



**User's Manual**  
**Rev 6a**

## **Notice**

Summa reserves the right to modify the information contained in this User Manual at any time without prior notice. Unauthorized copying, modification, distribution or display are prohibited. All rights reserved.

## Registering Your Cutter

Please register your cutter on the following link:

<https://www.summa.com/support/product-registration/>

Failure to register may result in delayed responses to your warranty and service inquiries.

## Contact Information

All inquiries, comments or suggestions concerning this and other Summa manuals should be directed to:

**Summa, nv**  
Rochesterlaan 6  
B-8470 GISTEL  
Belgium

[www.summa.com](http://www.summa.com)

**Summa America**  
100 Cummings Center Suite #151-G  
Beverly MA 01915  
USA

[www.summa.com/en-us](http://www.summa.com/en-us)  
[+1-978-522-4765](tel:+19785224765)





Welcome

## **Congratulations on your purchase of the new S CLASS 2 cutter!**

The S CLASS 2 cutters are built for sign-makers who demand the very best in cut quality.

Four versatile modes let you switch between Cutting, Cutting in FlexCut, Plotting or Pouncing. So even if your workspace is limited, your output options aren't.

Unrivalled tracking delivers guaranteed accuracy on cuts up to 12 meters (40 feet) long. This way you won't have to monitor your cuts, even when you're sending through long jobs.

The S CLASS 2 T series cutters with genuine tangential operation, and not simply "tangential emulation," handle a wider range of materials and cut with unparalleled precision.

In short, the S CLASS 2 cutters take cutting signs to a new level.

This manual is a reference guide for installing and operating the S Class series cutters.

Minimum revisions needed for this manual:

Firmware cutter: 026 (MD9981)

Cutter Control version 5.1 (installed from Cutter Tools version 2.2.0)

USB driver: version 6.4

Camera driver: revision1.0.136





## Table of Contents

<b>1</b>	<b>Setup</b>	<b>1-1</b>
1.1	<b>Unpacking the cutter</b>	<b>1-1</b>
1.1.1	Removing the packaging from the cutter	1-1
1.1.2	Setting up the stand	1-2
1.1.3	Mounting the cutter on the stand	1-4
1.2	<b>S CLASS 2 Cutter Components</b>	<b>1-5</b>
1.2.1	The Cutter as viewed from the front	1-5
1.2.2	The Cutter as viewed from the back	1-7
1.3	<b>Safety, Ideal Operating Environment, Connecting to the Mains</b>	<b>1-9</b>
1.3.1	<b>Safety</b>	<b>1-9</b>
1.3.1.1	General	1-9
1.3.1.2	Symbols used in the manual	1-9
1.3.1.3	Warning labels on machine	1-10
1.3.1.4	Safety precautions	1-10
1.3.2	Operating environment	1-11
1.3.3	Connecting the cutter to the mains	1-12
1.3.3.1	Grounding (“Earthing”)	1-12
1.3.3.2	Operating voltage	1-12
1.4	<b>Powering-on the cutter</b>	<b>1-13</b>
1.5	<b>Connecting the cutter to a computer</b>	<b>1-14</b>
1.5.1	<b>USB connection</b>	<b>1-14</b>
1.5.1.1	Connecting the S CLASS 2 cutter to a PC, using a USB cable	1-14
1.5.1.2	Connecting the S CLASS 2 cutter to a Mac using a USB cable	1-15
1.5.2	Ethernet connection	1-16
1.6	<b>Loading media</b>	<b>1-18</b>
1.6.1	Pinch roller positioning	1-18
1.6.2	Pinch roller pressure setting	1-19
1.6.3	Loading media	1-20
1.6.4	Media load procedure	1-23
1.7	<b>Tool Installation</b>	<b>1-27</b>
1.7.1	<b>Cutters with drag head</b>	<b>1-27</b>
1.7.1.1	Knife installation	1-27
1.7.1.2	Pen installation	1-30
1.7.1.3	Pouncing pin installation	1-30
1.7.2	<b>Cutters with tangential head</b>	<b>1-31</b>
1.7.2.1	Tangential knife installation	1-31
1.7.2.2	Pen installation	1-34
1.7.2.3	Pouncing pin installation	1-35
1.7.2.4	Drag knife installation	1-35
1.7.3	Replacement of the separation knife blade	1-36
1.8	<b>Activation of the barcode</b>	<b>1-37</b>

<b>2</b>	<b>Basic Operation .....</b>	<b>2-1</b>
<b>2.1</b>	<b>Touch Screen .....</b>	<b>2-1</b>
2.1.1	Touch screen .....	2-3
2.1.2	Settings .....	2-4
2.1.3	Actions .....	2-4
2.1.4	Origin.....	2-5
2.1.5	Configuration .....	2-5
2.1.6	Online/Pause.....	2-6
<b>2.2</b>	<b>How to Set Tool Parameters .....</b>	<b>2-7</b>
2.2.1	Setting the tool type .....	2-7
2.2.2	Changing the tool pressure .....	2-8
2.2.3	Changing the drag knife offset .....	2-8
2.2.4	Calibrating a tangential knife .....	2-9
<b>2.3</b>	<b>How to set the cutting speed .....</b>	<b>2-13</b>
<b>2.4</b>	<b>How to make sure the sign has the correct size.....</b>	<b>2-14</b>
<b>2.5</b>	<b>Cutting through .....</b>	<b>2-16</b>
2.5.1	Procedure.....	2-16
2.5.2	Practical tips .....	2-19
2.5.2.1	Physical knife depth tangential knife.....	2-19
2.5.2.2	Physical knife depth drag knife.....	2-20
2.5.2.3	Values of the FlexCut parameters.....	2-21
2.5.2.4	Material without a backing.....	2-22
<b>2.6</b>	<b>Dual Head (Optional) .....</b>	<b>2-23</b>
2.6.1	Introduction .....	2-23
2.6.2	Calibration Dual head .....	2-23
2.6.3	Settings in the cutting software .....	2-24
2.6.3.1	Using GoSign.....	2-24
2.6.3.2	Other software .....	2-24



<b>3</b>	<b>OPOS</b> .....	<b>3-1</b>
<b>3.1</b>	<b>Introduction</b> .....	<b>3-1</b>
<b>3.2</b>	<b>Basic OPOS operation</b> .....	<b>3-1</b>
3.2.1	Printing the graphic .....	3-2
3.2.2	Different OPOS alignment methods .....	3-3
3.2.3	Processing long jobs.....	3-4
<b>3.3</b>	<b>Automating OPOS tasks</b> .....	<b>3-5</b>
3.3.1	OPOS origin .....	3-6
3.3.1.1	In combination with OPOS X mode .....	3-6
3.3.1.2	In combination with OPOS XY, OPOS XY2 or OPOS Xtra mode .....	3-6
3.3.1.3	In combination with OPOS Barcode.....	3-7
3.3.2	Cutting multiple copies of a graphic on the same roll .....	3-8
3.3.3	Cutting the same graphic on multiple media sheets.....	3-10
3.3.4	OPOS Barcode.....	3-11
3.3.4.1	Introduction .....	3-11
3.3.4.2	Initiating the barcode procedure.....	3-12
<b>3.4</b>	<b>Calibrating OPOS</b> .....	<b>3-13</b>
3.4.1	OPOS calibration .....	3-13
3.4.2	Media calibration .....	3-14
<b>3.5</b>	<b>OPOS CAM</b> .....	<b>3-16</b>
3.5.1	General.....	3-16
3.5.2	Differences in calibrating OPOS CAM vs OPOS sensor .....	3-17
3.5.2.1	OPOS calibration .....	3-17
3.5.2.2	OPOS media calibration .....	3-17
<b>4</b>	<b>Detailed Operation</b> .....	<b>4-1</b>
<b>4.1</b>	<b>Introduction</b> .....	<b>4-1</b>
<b>4.2</b>	<b>Action Menu</b> .....	<b>4-1</b>
4.2.1	OPOS Barcode.....	4-1
4.2.2	OPOS sheet mode .....	4-1
4.2.3	Home .....	4-2
4.2.4	Cut Tests.....	4-2
4.2.5	Open file .....	4-2
4.2.6	G-Performance.....	4-3
4.2.7	Replot .....	4-3
4.2.8	Load.....	4-3
4.2.9	Cut Off .....	4-3
<b>4.3</b>	<b>Configuration Menu</b> .....	<b>4-4</b>
4.3.1	Settings.....	4-6
4.3.1.1	Tool.....	4-6
4.3.1.2	Velocity.....	4-6
4.3.1.3	Knife pressure .....	4-6
4.3.1.4	Calibrate Knife.....	4-6
4.3.1.5	Knife offset .....	4-7
4.3.1.6	Pouncing gap.....	4-7
4.3.1.7	FlexCut .....	4-7
4.3.1.8	Advanced cutting .....	4-8

G-Performance: .....	4-8
Overcut: .....	4-8
OptiCut: .....	4-8
Paneling: .....	4-8
Panel size: .....	4-9
Panel replot: .....	4-9
Sorting Vectors: .....	4-9
Long Vectors: .....	4-9
TurboCut: .....	4-9
4.3.1.9 General .....	4-10
Media sensor: .....	4-10
Recut offset: .....	4-10
Cut off margin: .....	4-10
Roll-up media: .....	4-10
Autoload: .....	4-11
Language: .....	4-11
Menu Units: .....	4-11
LCD contrast: .....	4-11
4.3.1.10 OPOS .....	4-12
Scan Speed: .....	4-12
Monitor: .....	4-12
4.3.1.11 Communication .....	4-13
Tool command: .....	4-13
USB class: .....	4-13
LAN: .....	4-13
4.3.1.12 Length calibration .....	4-14
4.3.1.13 Coil setup .....	4-14
4.3.1.14 Factory defaults .....	4-14
4.3.1.15 Copy current user .....	4-14
4.3.1.16 Media sensor setup .....	4-15
4.3.1.17 Calibrate touchscreen .....	4-15

---

<b>5</b>	<b>Maintenance and Cleaning .....</b>	<b>5-1</b>
<b>5.1</b>	<b>Introduction.....</b>	<b>5-1</b>
5.1.1	Cleaning the drive system .....	5-1
5.1.2	Cleaning the media sensors .....	5-1
5.1.3	Cleaning the Y-Guide Rail .....	5-2
5.1.4	Cleaning the nose piece (tangential machine only).....	5-2
5.1.5	Cleaning the OPOS system .....	5-3
5.1.6	Changing the fuse.....	5-4
<b>6</b>	<b>Specs and General Information.....</b>	<b>6-1</b>
<b>6.1</b>	<b>Introduction.....</b>	<b>6-1</b>
6.1.1	Product features .....	6-1
<b>6.2</b>	<b>Specifications .....</b>	<b>6-3</b>
6.2.1	Cutter .....	6-3
6.2.2	Media.....	6-3
6.2.3	Knife, pen and pouncing tool.....	6-4
6.2.4	Interface.....	6-5
6.2.5	Firmware .....	6-5
6.2.6	Performance.....	6-6
6.2.7	Environmental.....	6-7
6.2.8	Electrical .....	6-7
<b>6.3</b>	<b>Cutter accessories and consumables .....</b>	<b>6-8</b>

## List of Figures

1-1 S CLASS 2 cutter fully boxed .....	1-1
1-2 Contents of the Stand box .....	1-2
1-3 Mounting the horizontal panel .....	1-2
1-4 Mounting feet and casters .....	1-2
1-5 Mounting the basket tubes .....	1-3
1-6 Preparing to install the linen basket .....	1-3
1-7 Orientation of the holes in the c-shaped tubes .....	1-3
1-8 Completely assembled stand for the S CLASS 2 cutter .....	1-4
1-9 Position of the screws .....	1-4
1-10 S CLASS 2 cutter, front view .....	1-5
1-11 S CLASS 2 cutter, rear view .....	1-7
1-12 Properly grounded connection .....	1-12
1-13 Cutter is loaded and ready .....	1-13
1-14 Cutter is ready - no media loaded .....	1-13
1-15 Position pinch rollers .....	1-18
1-16 reducing pressure .....	1-19
1-17 Pinch roller lever .....	1-20
1-18 Media flanges .....	1-20
1-19 Positioning the media flange on the cutter .....	1-20
1-20 Feeding roll media without using media flanges .....	1-21
1-21 Media position .....	1-21
1-22 Pinch roller lever .....	1-22
1-23 Removing the drag knife holder from the clamp .....	1-27
1-24 Removing the knife from the standard drag knife holder .....	1-27
1-26 Dual clamp drag head .....	1-28
1-27 Knife pressure test pattern .....	1-29
1-28 Removing the tangential knife holder .....	1-31
1-29 Removing the knife from the tangential knife holder .....	1-31
1-30 Blade assembly .....	1-32
1-31 Inserting the tangential knife holder .....	1-32
1-32 Knife depth adjustment .....	1-32
1-33 Knife pressure test pattern .....	1-33
1-34 Razor blade for automatic separation of media .....	1-36
2-1 Touch screen .....	2-1
2-2 screen saver .....	2-2
2-3 Online status screen .....	2-6
2-4 Correct knife offset pattern .....	2-9
2-5 Possible knife calibrations .....	2-10
2-6 Correct tangential knife calibration test .....	2-11
2-7 Length calibration pattern .....	2-14
2-8 FLexcut principle .....	2-16
2-9 Combined contour cut and cutting through .....	2-18
2-10 Knife depth setting normal cutting .....	2-19
2-11 Knife depth setting cutting through .....	2-19
2-12 Knife depth setting normal cutting .....	2-20
2-13 Knife depth setting cutting through .....	2-20
2-14 Dual head .....	2-23
3-1 margins printing on a roll .....	3-2
3-2 OPOS alignment methods .....	3-3
3-3 Positioning the media for multiple sheets .....	3-10
3-4 Opos barcode Job loaded .....	3-11
3-5 Opos Cam .....	3-16

4-1 Action menu.....	4-1
4-2 Configuration menu .....	4-4
4-3 Configuration menu .....	4-5
4-4 Overcut .....	4-8
4-5 Sensor setup .....	4-15
5-1 Media sensors S Class 2 cutters.....	5-1
5-2 Sliding surfaces on Y-guide rail.....	5-2
5-3 Cleaning the OPOS sensor .....	5-3
5-4 Power entry module .....	5-4

**List of Tables**

6-1 S CLASS 2 Cutter specifications.....	6-3
6-2 S CLASS 2 Media specifications.....	6-3
6-3 S CLASS 2 Tools.....	6-4
6-4 S CLASS 2 Interface specifications.....	6-5
6-5 S CLASS 2 Firmware .....	6-5
6-6 S CLASS 2 Performances.....	6-6
6-7 S CLASS 2 Environmental Specifications.....	6-7
6-8 S CLASS 2 Accessories for drag series.....	6-9
6-9 S CLASS 2 Accessories for tangential series .....	6-11
6-10 S CLASS 2 General Accessories .....	6-12



## 1.1 Unpacking the cutter



**NOTE:** Save the shipping box and any other packaging items in case the cutter needs to be shipped. Do not ship the cutter without first completely repacking it in its original packaging. A document explaining how to repackage is available.



**WARNING:** For safety reason no fewer than two people should be involved in unpacking the cutter.

Before unpacking the cutter, make sure there is enough space to assemble the stand and to set the cutter aside in order to insert the stand screws.

### 1.1.1 Removing the packaging from the cutter

1. Remove the straps and the staples and open the lid of the box.
2. The cutter is packed in foil and is situated in front of the box. The box, containing the stand, is situated behind the cutter. The accessories are located at the bottom in a separate box. Firstly, check whether everything is present.
3. Do not throw away the packaging. Shipping it without the original box voids any warranty.



FIG 1-1  
S CLASS 2 CUTTER FULLY BOXED

### 1.1.2 Setting up the stand

1. Verify whether the stand is complete. The box containing the stand should contain following:
  - a. 2 legs, left and right
  - b. 2 feet, left and right
  - c. A horizontal panel
  - d. Media flanges
  - e. A total of 7 tubes for the [media] basket
  - f. A linen media basket
  - g. A bag of 4 casters, screws and other accessories to mount the stand



FIG 1-2  
CONTENTS OF THE STAND BOX

2. Mount the horizontal panel between the two legs of the stand with four screws at each side.



FIG 1-3  
MOUNTING THE HORIZONTAL PANEL

3. Turn the stand upside down and mount the 2 feet at each side with four screws. Make sure to position the feet in this way all the holes in the feet correspond to the holes in the legs (left and right), as in the picture below (1). The four holes in the feet all point towards the middle (2). Screw in the four casters.



FIG 1-4  
MOUNTING FEET AND CASTERS



- Attach the four tubes for the basket on the left and right, as shown in figure 1-5 below. Put the end cap (1) and the two saddle clips (2) on each tube in order to fix the tube in its place. Position the shorter tube (3) at the rear side (side of the horizontal panel).



FIG 1-5  
MOUNTING THE BASKET TUBES

- Turn the stand upright and put the media basket on the horizontal panel as shown in figure 1-6 below.



FIG 1-6  
PREPARING TO INSTALL THE LINEN BASKET

- Take one of the large c-shaped tubes and put it through the front hem in the linen basket. Make sure the holes are oriented with the right side upwards, so that the tubes click in place securely. Then put the tube on the two front tubes that stick out of the feet. Slide the tubes together while pressing down the spring-loaded ball stopper until the ball locks into place.



FIG 1-7  
ORIENTATION OF THE HOLES IN THE C-SHAPED TUBES

- Click a saddle clip onto one side of the tube. Insert the other end of the tube through the middle hem of the linen basket and then into the hole in the leg of the stand. Guide the other end of the tube into the hole on the leg and secure with a saddle clip.

8. Make sure the linen basket is guided under the horizontal panel. Take the last large c-shaped tube and feed it through the rear hem in the linen basket. Then put the tube on the two rear tubes that stick out of the feet. Make sure the holes are orientated with the right side upwards, so that the tube clicks securely on the tubes. The finished stand should look like the stand in the picture below (Figure 1-8).



FIG 1-8  
COMPLETELY ASSEMBLED STAND FOR THE S CLASS 2 CUTTER

9. The right leg contains a hole in the foot and a cutout in the leg in order to guide the power cable and data cable. If you plan to use these cable guides, then put the cables in place before mounting the cutter on the stand.

### 1.1.3 Mounting the cutter on the stand

1. Carefully take the cutter out of the box and lay it on its back (first spread out the cardboard of the stand box, and then rest the cutter on that cardboard). Insert the left and right two screws and turn them 3 turns in. Do not put a screw in at the front.



FIG 1-9  
POSITION OF THE SCREWS

2. Put the cutter on its stand. Put a lockwasher on the two remaining screws and put them in the two remaining holes. Then secure all six screws.
3. Loosen the cutting head. Raise the pinch rollers to remove the protection strip from underneath the pinch roller assemblies.

## 1.2 S CLASS 2 Cutter Components

### 1.2.1 The Cutter as viewed from the front



FIG 1-10  
S CLASS 2 CUTTER, FRONT VIEW

- 1. Pinch rollers:** The pinch rollers clamp the media to the drive system to ensure accurate tracking. The S120(T) has one and the S160(T) and S 140(T) have two extra pinch rollers to ensure that wide media stays flat in the middle. The outer drive pinch rollers have a selectable pressure; the extra rollers in the middle can be enabled or disabled. Extra pinch rollers can be added.

Number of pinch rollers	S75	S120	S140	S160
Dual pressure	2	2	2	2
Low pressure	0	1	2	2

- 2. Touch panel:** All cutter activity can be initiated from the 320x240 dot touch panel. The panel displays information about the cutter's current status and/or actions that need to be taken.
- 3. Pinch roller lever:** This lever is used to raise and lower the pinch rollers for media loading.

4. **Media drive sleeves:** The media drive sleeves only move the media when the pinch rollers are in the “down” position. The following table lists the number of sleeves installed on each model of the S CLASS 2 cutters.

Number of sleeves	S75 (T)	S120 (T)	S140 (T)	S160 (T)
Short sleeve	4	7	8	9
Long sleeve	1	1	1	1

5. **Tool carriage:** The tool carriage is the carriage for the knife holder, pen or pouncing tool. It also holds the Optical POSitioning sensor (OPOS) and a cut-off knife to cut a sheet from the roll when a job is finished.
6. **Cutting strip:** A self-healing orange strip helps avoid any damage to the knife tip when no media has been loaded. Since cutting is done on the cutting strip, it is essential that the strip remains intact.
7. **Pouncing strip:** An extra black strip to pounce on.
8. **Tool holder:** The left end cap has a rim so it can be used for tool storage.
9. **Screws to secure the cutter base:** Make sure all three screws are secured at each side before the cutter is used.
10. **Media basket:** The stand and linen media basket come standard with all S CLASS 2 cutters.

## 1.2.2 The Cutter as viewed from the back

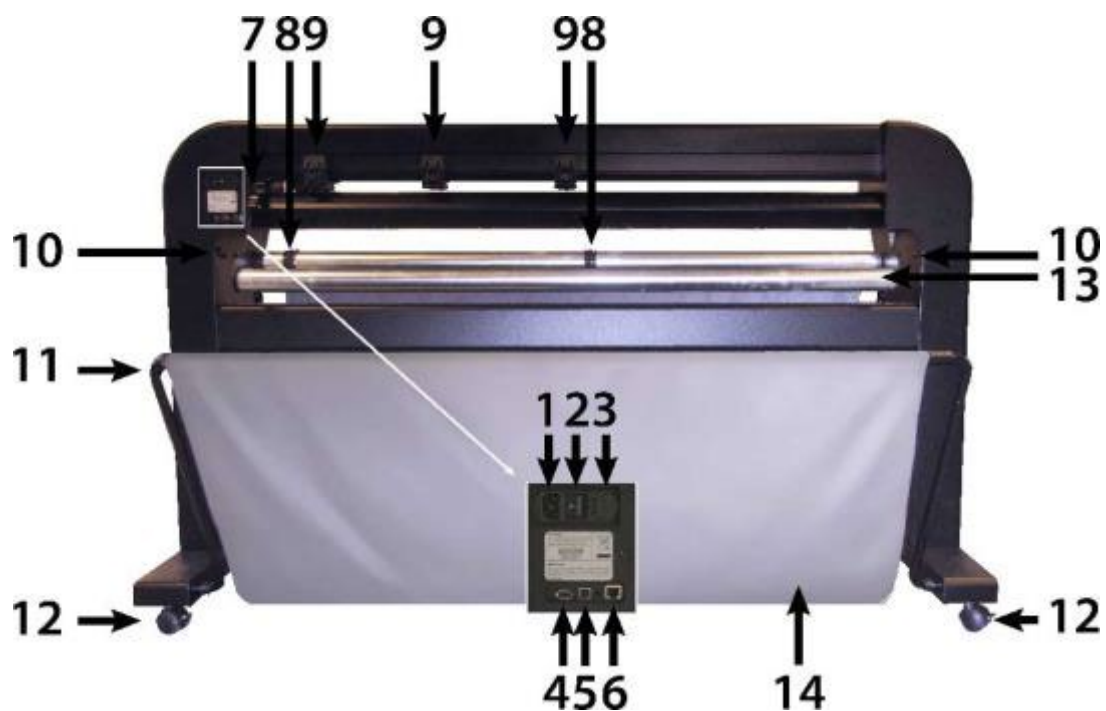

FIG 1-11  
S CLASS 2 CUTTER, REAR VIEW

1. **AC power cord receptacle:** It is located at the left-hand side of the power entry module. The power-up procedure is explained in detail in section 1.3. Always use a power cord that was delivered with your cutter.
2. **Power On/Off switch:** This rocker switch, in the middle of the power entry module, sets the cutter's power to ON or OFF. To switch on the power, press the "I" side of the rocker switch. To switch off the power, press the "O" side of the rocker switch.
3. **The fuse box:** The fuse is located at the right side of the power entry module. Check the specification section to see which fuse is used in the S CLASS 2 cutter.



**WARNING:** For continued protection against risk of fire, replace only with the same type and rating of fuse.

4. **USB port type A female:** For plugging in a USB stick.
5. **Ethernet port RJ45:** For connecting the cutter to the LAN.
6. **USB port Type B female:** This interface is based on the standards, specified in the Universal Serial Bus Specifications Revision 1.1. It allows a high-speed bi-directional communication between the host computer and the cutter.
7. **Pinch roller lever:** This lever is used to raise and lower the pinch rollers for media loading.
8. **Roll media guide bushes:** The two flange guides serve to keep the media roll in place when media is pulled from the roll.

- 9. Pinch rollers:** The pinch rollers clamp the media to the drive system to ensure accurate tracking. The S2120(T) has one and the S2160(T) and S2140(T) have two extra pinch rollers to ensure that wide media stays flat in the middle. The outer drive pinch rollers have a selectable pressure; the extra rollers in the middle can be enabled or disabled. Do not move the pinch roller assemblies when holding them from this side.
- 10. Screws to secure the cutter base:** Screws (3 left and 3 right) hold the cutter base on its stand. All the screws must be properly secured before using the cutter.
- 11. Tubes for the media basket:** Tubes in the back and front hold the media basket. They can easily be pulled outwards to put the basket in its place.
- 12. Casters:** The casters on the stand are equipped with locking brakes. Once the cutter has been moved to its new location, press the brakes with your foot to lock the casters.
- 13. Media support rollers:** Rotating support rollers for the media roll.
- 14. Media basket:** The stand and linen media basket come as standard equipment with all S CLASS 2 cutters.

## 1.3 Safety, Ideal Operating Environment, Connecting to the Mains

### 1.3.1 Safety



**WARNING:** This equipment is not suitable for use in locations where children are likely to be present.

#### 1.3.1.1 General

The purpose of the user's manual is not only to explain the operating procedures of this machine, but it also provides the owner, users and operators with precaution procedures for safe and proper machine operation for its intended purpose.

All information in this manual must be read and understood before any attempt is made to operate the machine.

The manufacturer has no direct control over the machine operation and application. Proper safety practice is the sole responsibility of the owner, user and operator.

All instructions and safety warnings in this manual are based upon the use of this machine under proper operating conditions without alterations from the original design.

Any use of the cutter that is beyond the capabilities of the combination knife/material is considered as improper use and may result in injury and serious damage to the machine and will lead to loss of warranty.

#### 1.3.1.2 Symbols used in the manual



---

Warning with dark (red) symbol: Refers to immediate threat that can cause serious injuries and effects on health and safety.

---



---

Warning with light (yellow) symbol: Refers to a dangerous situation that can cause injuries and serious damage to the machine.

---



---

Attention with dark (red) symbol: Refers to useful information to prevent damage to the equipment and prolong the service life of the machine.

---



---

Attention with light (yellow) symbol: Refers to useful tips to enhance the user-friendliness and make the work significantly easier.

---



---

Note: Can be considered as a general tip; something that is useful to know.

---

## 1.3.1.3 Warning labels on machine



The S Class 2 cutters use razor-sharp knives. Touching the knife with bare hands may cause injury.

Hazardous moving part. Keep your fingers and other body parts away from this area.

This label is located on the cutting head.

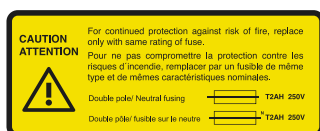

Fuse caution label. For continued protection against risk of fire, replace the fuse only with one of the same rating.

Double pole/Neutral fusing

This label is located near the power inlet, at the rear.

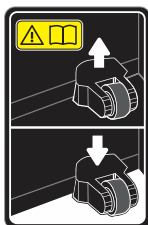

Caution: Always leave the pinch rollers in the upper positions when the cutter is not in use.

This label is located on the side of the scan axis.

## 1.3.1.4 Safety precautions



**WARNING:** The S CLASS 2 cutters use razor-sharp knives. Touching the knife with bare hands may cause injury. Do not touch the knives while the machine is cutting.

The cutter comes with a tool to insert the knives in the knife holder. Use this tool to prevent injury. Put used blades in their original packaging for disposal.



**WARNING:** There is a risk of injury from being caught or trapped in moving machine parts.

Keep hands, hair, clothing and jewelry away from moving parts. Do not wear jewelry, loose clothing, scarves, open jackets or shirtsleeves.

The entire base plate should be considered as a dangerous area when the cutter is switched on and off. The tool carriage can move from the left to the right and the yellow media sleeves are sharp and can grab loose objects, clothing or body parts.

The cutter constantly measures the current through the motors. If the machine detects the current is too high, then the current will be cut off to the motors and a fatal error message will be displayed on the control panel.

Make sure to observe all the caution labels on the cutter.



### 1.3.2 Operating environment

Environmental conditions can significantly affect the machine's performance.

The environmental conditions of the machine (without media) are as follows:

<b>Operating Temperature</b>	15 to 35° C	59 to 95° F
<b>Storage temperature</b>	-30 to 70° C	-22 to 158° F
<b>Relative humidity</b>	35 - 75 %, non-condensing	35 - 75 %, non-condensing

It is possible that the environmental conditions of the used media are stricter than those of the machine itself. Please refer to the documentation about the used media.

Moreover, make sure that the media has had enough time to acclimatize.



**NOTE:** Keep the cutter away from direct sunlight or a strong indoor light source. The optical sensors in the machine may be affected, thus causing unexpected behavior of the cutter.

### 1.3.3 Connecting the cutter to the mains

#### 1.3.3.1 Grounding ("Earthing")

**WARNING:** An insulated ground conductor must be installed as part of the branch circuit that supplies power to the wall outlet, connected to the cutter.. The ground conductor must have the same size, insulation material and thickness as the grounded and ungrounded branch-circuit-supply-conductors, but the insulating seat should be green or green with yellow striping.



The ground conductor described above must be grounded at the electrical distribution board or, if power is supplied by a separate system, at the power supply transformer/motor generator set.

The wall sockets, into which the cutter is plugged-in, must be of the grounded type. The grounded conductors, serving the wall socket, must be properly connected to the ground.

For emergency access, the cutter should be installed near the socket-outlet for easy access.

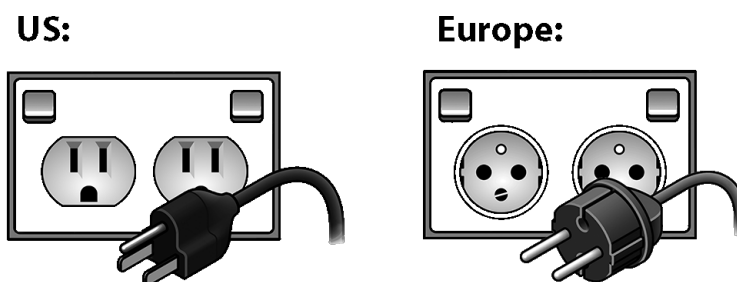

FIG 1-12  
PROPERLY GROUNDED CONNECTION

#### 1.3.3.2 Operating voltage

Operating voltage: 100-240V 50/60 Hz

Fuse Rate: T2AH 250V SCHURTER SPT OR EQUIVALENT.



**WARNING:** Before changing the fuse, make sure that the cutter is completely disconnected from its power source.



**WARNING:** For continued protection against risk of fire, replace only with the same type and rating of fuse.

## 1.4 Powering-on the cutter



**WARNING:** Make sure the power switch is turned off before connecting the power cord (the “0” side of the ON/OFF rocker switch should be pressed).



**WARNING:** Do not use the power cord if it is visibly damaged. Disconnect the power cord by pulling the **plug**, not the **cable**.



**WARNING:** Keep fingers and other body parts away from the cutting area. There are **hazardous moving parts**.

1. Plug the female end of the AC power cord into the receptacle, located in the power entry module at the cutter's rear panel.
2. Plug the male end of the AC power cord into a properly grounded wall socket.
3. Power on the cutter by pressing the “I” side of the ON/OFF rocker switch, which is located on the power entry module at the rear panel.
4. The touch screen will activate and the initialization process will begin. If media is loaded, the cutter will check the size and load the media.

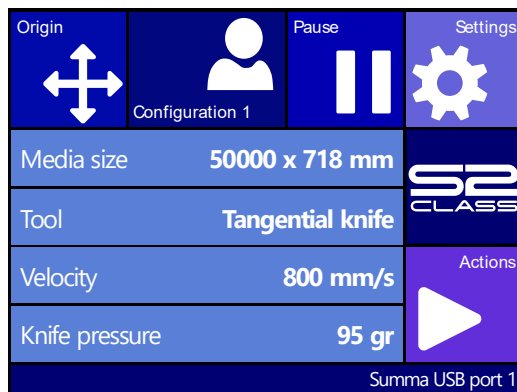

FIG 1-13  
CUTTER IS LOADED AND READY

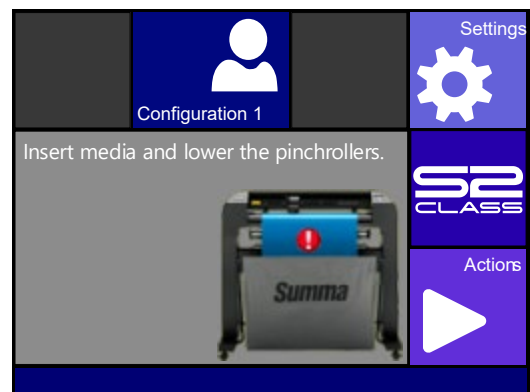

FIG 1-14  
CUTTER IS READY - NO MEDIA LOADED

## 1.5 Connecting the cutter to a computer

The S CLASS 2 cutters support bi-directional USB and Ethernet connectivity. When both ports are connected at the same time, the port that receives the data first will remain active and the other port will be deactivated.

### 1.5.1 USB connection

The USB cable should be 5 meters (16 feet) or less in length. The connector on the cutter side of the cable should be USB series B 4-pin. The connector on the computer side of the cable should be USB A 4-pin.

#### 1.5.1.1 Connecting the S CLASS 2 cutter to a PC, using a USB cable



**NOTE:** When installing a cutter, make sure the user has administrative rights and UAC is deactivated or set it to its lowest level.

1. Install the USB driver (downloaded from the internet).
2. Connect one end of the USB cable to a USB port on the computer.
3. Connect the other end of the USB cable to the USB port at the back of the cutter.
4. Power on the cutter and return to the computer.
5. Click "OK" and follow the instructions, provided by the Wizard on the computer. Windows will find and install the driver.
6. Restart the computer.



**NOTE:** When connecting a cutter to a computer for the first time, using the USB cable, the computer will detect the cutter and install the USB driver if the setup program was run. If the setup program was not run prior to connection, then install the program while the cutter is connected and switched on. After the program is run, the computer will detect a new device and install the correct driver automatically.



**NOTE:** In order to connect more than one cutter to one computer, see the section on the USB class.

### 1.5.1.2 Connecting the S CLASS 2 cutter to a Mac using a USB cable

➤ Mac OSX

Most recent cutting software does not need a driver installation when a computer is connected to the cutter. The software that controls the driver is built into the cutting software.

## 1.5.2 Ethernet connection

A couple of parameters need to be set when connecting a cutter to the Ethernet. It is best to ask the network administrator whether a static address is needed or if a DHCP server is used. If a static address is used, ask for the address and the subnet mask.

- In case the DHCP server is used:

Just connect the cutter and write down the IP address to set up the cutting software.

*Check the IP address in the communication menu:*

1. Power on the cutter (see section 1.4) and connect the Ethernet cable.

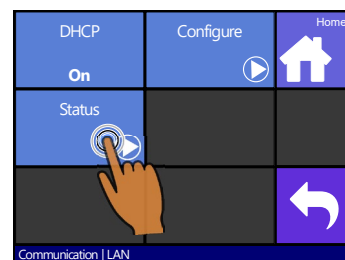
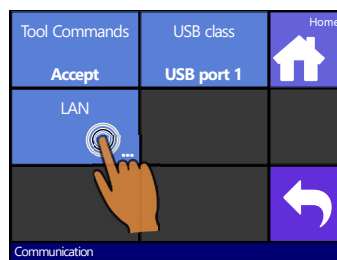
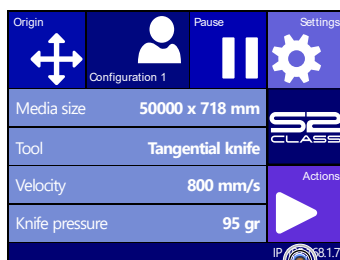

2. Press status bar

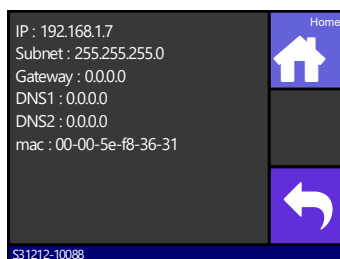

3. Press LAN

4. Press Status

*The IP address (and other network settings) are shown on the screen.*



**NOTE:** it is recommended to work with a static IP address. If no static IP address is used, it is possible that the IP address of the cutter suddenly changes and that the cutter software does not function anymore.

- Use static address:

The static address that you received from the network administrator will be used in the software to drive the cutter. It also needs to be set in the cutter itself.



**NOTE:** The default DHCP setting for the cutter is On. If the setting has already been changed to “Off” then leave it at that, otherwise change it to this value as described below.

1. Power on the cutter (see section 1.4) and connect the Ethernet cable.

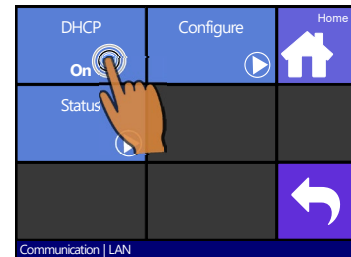
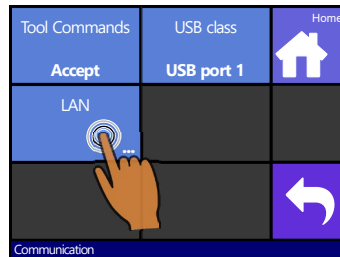
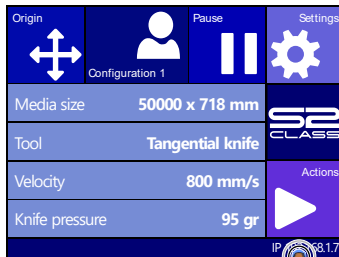

2. Press the status bar

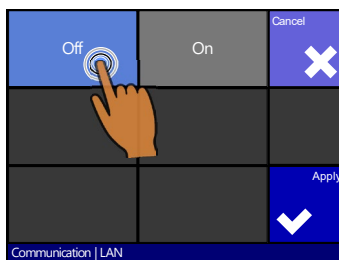

3. Press LAN

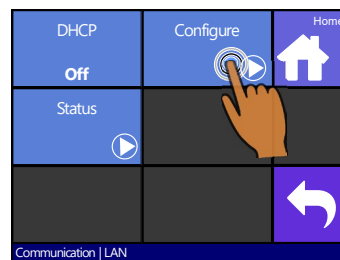

4. Press DHCP

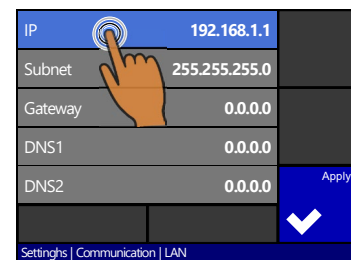

5. Press off and then Apply

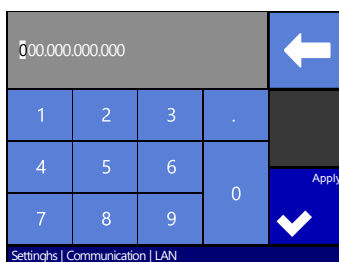

6. Press Configure

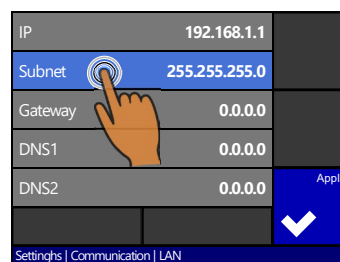

7. Press the parameter that needs to be changed

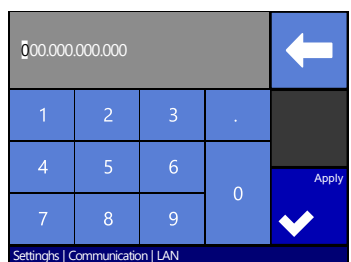

8. Set the address correctly and press apply

9. Press the parameter that needs to be changed

10. Set the address correctly and press apply

## 1.6 Loading media

The following procedures apply mainly to the use of roll media. If you are using sheets, there are two options:

For long sheets, roll up the sheet so that the alignment is identical to that of a roll.

For short sheets, the alignment is not so important. If the sheet is cut off perpendicularly, it can be aligned to the front border.

### 1.6.1 Pinch roller positioning

Proper movement of the media will only occur if the media is driven by the two outer pinch rollers, which are correctly located over two drive sleeves.

The pinch rollers are lowered or raised simultaneously by means of the pinch roller lever arm, located on the right-hand side of the cutter. The pinch rollers must be lifted to allow vinyl loading, during which the media is fed from the rear of the cutter to the front. When raised, the pinch rollers can be moved manually to the left or the right along the pinch roller shaft.



**CAUTION:** Always make sure that the pinch rollers are fully raised before sliding them to the left or right.

Always hold the assembly at the side of the pinch roller to move it from left to right. Do not reposition the pinch roller by holding the assembly at the rear of the machine.

The pinch rollers **MUST** be positioned correctly and lowered onto the media before an automatic load sequence is initiated. Make sure that all the pinch rollers are positioned above a drive sleeve. The outer left pinch roller should be positioned in one of the detents (click position), just underneath a white triangular label. The outer right pinch roller should be positioned somewhere over the long drive sleeve. Click positions are located at the edges of the sleeve (area marked with a white triangular label).

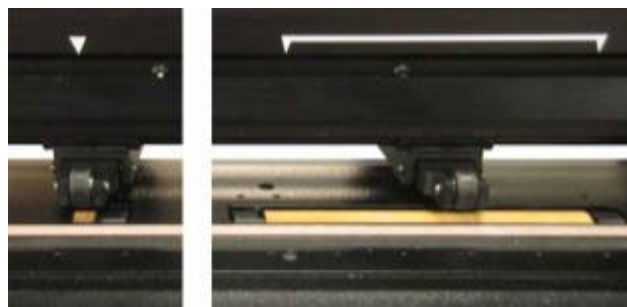

FIG 1-15  
POSITION PINCH ROLLERS



**CAUTION:** Always leave the pinch rollers in the “up” position when the cutter is not in use. Leaving the pinch rollers in the “down” position for a long time will result in a flat spot in the pinch rollers, which will seriously [negatively] affect tracking performance and cutting quality.



**NOTE:** The pinch rollers are a kind of emergency stop. If they are raised, then every movement stops.



## 1.6.2 Pinch roller pressure setting

The S CLASS 2 cutters are equipped with selectable pinch roller pressure. The pressure can be set to “standard” or “low.” The change in pressure should only be done when the pinch rollers are in the down position. When reduced pressure is needed, it is advised to set autoloader to ‘ASK’. Then the cutter will not start to load the vinyl when the pinch rollers are set down or when the cutter is switched on. A message will appear on the touch screen, giving the user time to change the pressure on the pinch rollers.



**NOTE:** Each time the pinch rollers are raised, the pressure is automatically reset to full pressure.

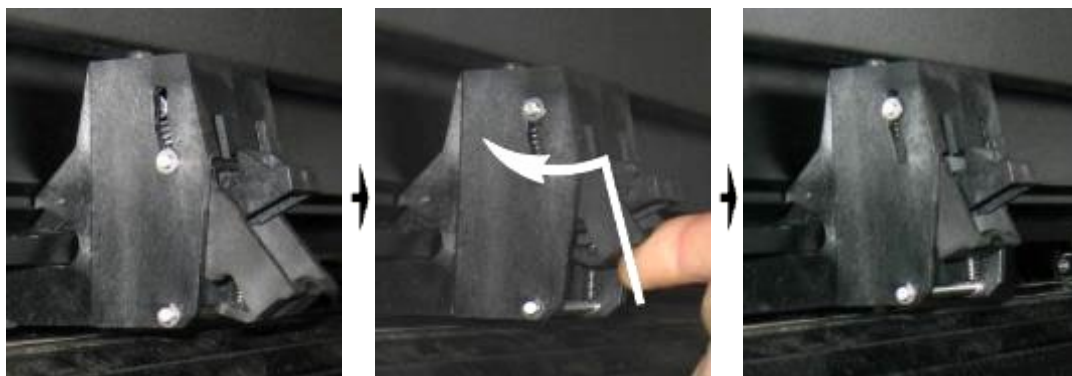

FIG 1-16  
REDUCING PRESSURE

To work with reduced pressure, do the following:

1. Set AUTOLOAD to ASK (see the section on Autoloader:).
2. Load the media in the cutter (see the section on Media load procedure).
3. Push the lever of the two outer pinch rollers upwards and inwards (toward the machine) – see figure above.

### 1.6.3 Loading media

1. Raise the pinch rollers by means of the pinch-roller-lever arm, which is located on the right-hand side of the cutter, next to the touch panel.

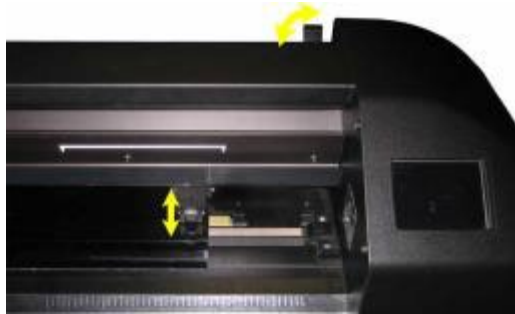

FIG 1-17  
PINCH ROLLER LEVER

2. Loosen the knobs on the two media flanges. The following illustration shows a loosened flange (1) and a tightened flange (2).



FIG 1-18  
MEDIA FLANGES

3. Insert a loosened flange into one end of the media roll and tighten the knob. Verify that the flange is secure. Then do the same on the other side of the roll.
4. Place the flange-equipped roll on the media supply rollers. Set the flanges inside the groove of the flange guide. The flange guides can be moved laterally on the roller.



FIG 1-19  
POSITIONING THE MEDIA FLANGE ON THE CUTTER



**NOTE:** If the flanges are not used (not recommended – tracking is not guaranteed), then make sure that the roll is situated between the two flange guides.



FIG 1-20  
FEEDING ROLL MEDIA WITHOUT USING MEDIA FLANGES

5. Start feeding the media from the rear of the machine. Pass the media underneath the pinch rollers towards the front of the machine.
6. Position the left media edge on the left-most drive sleeve and check whether the right media edge is positioned over the long drive sleeve. Then position the left and right pinch rollers.

The pinch rollers should be positioned over the drive sleeves about 3 to 15 mm (0.1" to 0.6") away from the media's outer edges (1). Then pull the media while holding the flange at the back so the media is tight. Make sure the front media sensor is covered (2).



FIG 1-21  
MEDIA POSITION

In circumstances where the above procedure does not work, because the media is too narrow to reach the long drive sleeve, try positioning the left media edge over the second left drive sleeve and position the right media edge somewhere over the long drive sleeve. Continue moving the left pinch roller toward the long drive sleeve until both pinch rollers click in their designated position and directly over the edges of the vinyl.

In all cases, both edges of the media must cover a drive sleeve. If this is not the case, reposition the roll of material to cover the drive sleeve.

7. Make sure that the media follows a straight path from the roll of material. To accomplish this, slide the media roll and flange guides from the left to the right along the media support rollers.



**WARNING:** Keep fingers and other body parts away from the cutting area. There are hazardous moving parts.

8. Lower the pinch roller lever to press the media firmly against the drive sleeves. The tool carriage will move automatically from the right to the left to sense the usable media width.

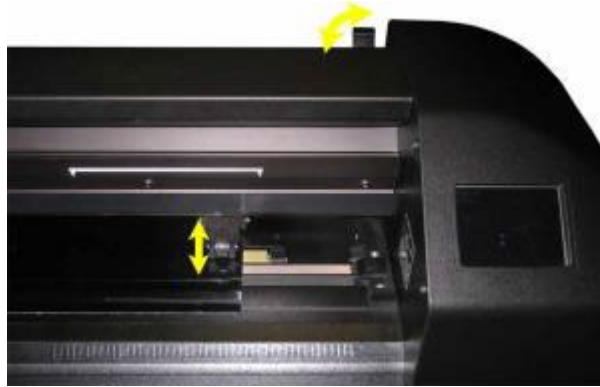

FIG 1-22  
PINCH ROLLER LEVER



**NOTE:** It is not recommended to unroll the media manually from the roll. The cutter will unroll the media automatically during the load sequence.

9. The positioning and routing of sheet material is identical to that of roll media.
10. The cutter is now ready.

### 1.6.4 Media load procedure



**CAUTION:** Do not place any objects in front of, or behind, the cutter that could interfere with the cutter operation. Make sure the media is free to move forward and back. Keep hands, hair, clothing and jewelry away from moving parts.

While the cutter is activated, it will automatically start executing a minimal loading procedure as soon as the pinch rollers are lowered. The load procedure will also start when the cutter is switched on while the media is already in the machine and the pinch rollers are in the “down” position (this is not recommended). Always keep the pinch rollers in the up position while the cutter is not in use.

The minimal loading procedure consists of:

- The media will first move forward to make sure no dog ears of the media are in the path of the tool carriage
- A media-width measurement with the tool carriage
- The media is unwound over 80 cm (32 inch).
- A simultaneous 45° axial move of the drive drum (sleeves) and cutting head to check the media weight.

The cutter is now ready to receive files from the computer.

When receiving a job from the computer, the cutter will automatically pull the required media from the roll. This happens gradually and the length of the used vinyl is equal to several measured widths of the media.



**IMPORTANT:** Tracking of longer signs can only be guaranteed when the full load procedure is performed!

Full media load procedure is done manually via the keyboard.

There are 3 different loading procedures.

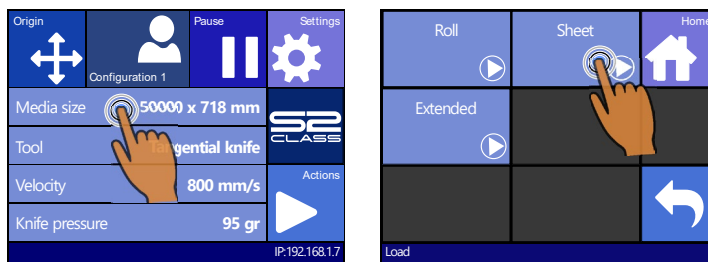

**WARNING:** Each keystroke can initiate an internal test or movement of the head or media. Keep fingers and other body parts away from the cutting area. There are hazardous moving parts.

*Loading a sheet.*



1. Press on Media size
2. Press on Sheet

*The cutter will immediately start to load the sheet. It loads until the end of the media or a certain length of media is reached. The user will then be prompted to accept the length or not.*

3. Press  to accept the length or go to step 4.

*The cutter will now complete the loading sequence, come online and will be ready to receive data. The loading sequence conditions the edges of the vinyl for a given length.*

4. Press  .

5. Press  or  until the required media-length appears. Then press  .

*The cutter will now complete the loading sequence. The cutter will come online and will be ready. The length of the job is limited to the loaded length.*



**NOTE:** If the rear media sensor detects the end of the media, the cutter will complete the loading sequence without any input from the user.



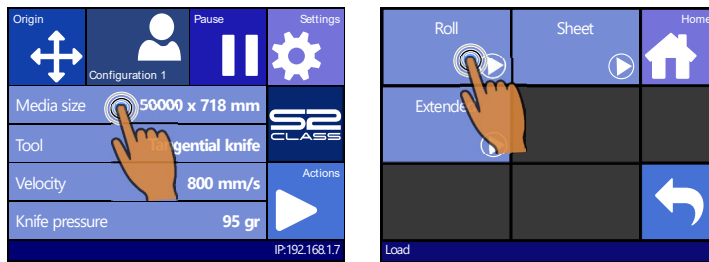

**Loading a roll.**



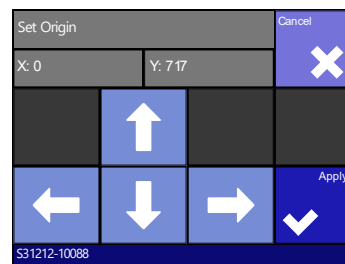



1. Press on Media size
2. Press on Roll

Four arrows will appear, together with an “apply” button. The status is visible in the middle of the right-hand side of the screen.



3. Use  ,  ,  or  to reposition the origin, if necessary. Then press .

Two arrows will stay on the screen in order to load the necessary length.

4. The media length needed for the task can be entered by pressing  or  . Or the needed length for the job can be entered by pressing  and then by pressing  or  to change the value of the default length to load.

Depending on the chosen manner for entering the needed length of the job, the cutter will either load the length or display the chosen length on screen.

5. Press .

The cutter will now complete the loading sequence. The cutter will come online and will be ready. The length of the job is limited to the actual length of the media, left on the roll. The cutter will always assume a full roll, which means it will use 50000mm (1982 inches) on the status screen.



**NOTE:** If the rear media sensor detects the end of the media, the cutter will complete the loading sequence without any input from the user.

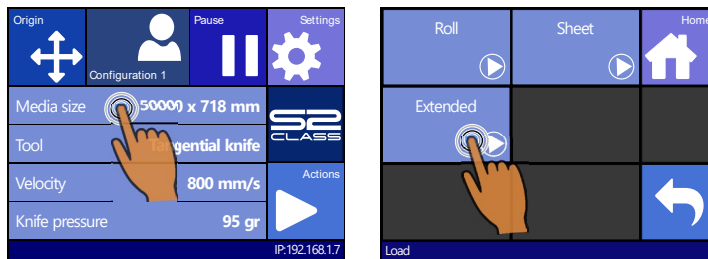

**Extended load.**

The function extended load makes it possible to define the limits of the Y axis so that the cutter can cut outside the pinch rollers. The media needs to be loaded before this function can be used.





1. Press on Media size
2. Press on Extended

*Two arrows will appear, together with an “apply” button.*

3. Use  or  to reposition the right Y-axis limit (origin). Then press .

*Two arrows will stay on the screen. The tool carriage will move to the left Y-axis limit.*

4. Use  or  to reposition the left Y-axis limit (define size). Then press .

*The cutting area in the Y-axis has now been redefined.*



**NOTE:** Tracking is not guaranteed when using this mode.



## 1.7 Tool Installation



**WARNING:** The S CLASS 2 cutters use razor-sharp knives. To avoid serious injury, be careful when installing, removing or handling the knife!

### 1.7.1 Cutters with drag head

#### 1.7.1.1 Knife installation

A knife is pre-installed in the cutter.

For safety reasons, the knife depth has been set to zero. Simply turn out the knife (see FIG 1-23 yellow arrow clockwise) to start cutting. Please find the complete description of the knife removal and knife installation below.

#### *Removing the drag knife*

1. Loosen the head clamp screw (1), swing the clamp arm back and remove the knife holder from the clamp (2).

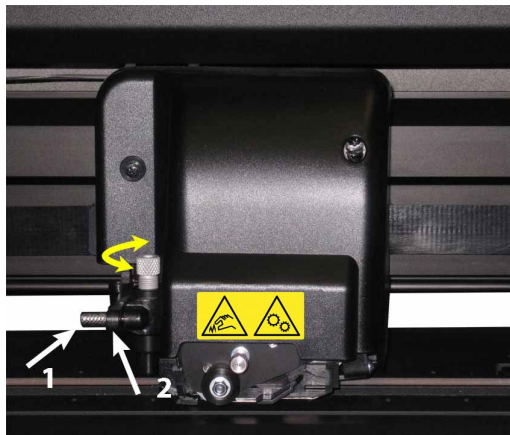

FIG 1-24  
REMOVING THE DRAG KNIFE HOLDER FROM THE CLAMP

2. Turn the knurled adjustment knob (3) clockwise to push the knife (4) out of the holder (5).

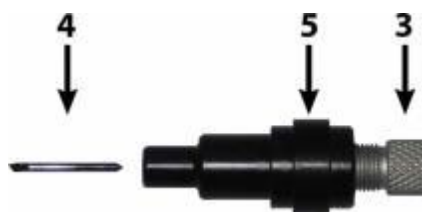

FIG 1-25  
REMOVING THE KNIFE FROM THE STANDARD DRAG KNIFE HOLDER

3. Carefully pull the knife from the holder.

*Installing the drag knife*

1. Remove the aluminum part from the plastic knife holder (5) by turning the knurled adjustment knob (3) counterclockwise until the aluminum part comes out of the holder.
2. Insert the conical, non-cutting end of the knife into the opening in the narrow end of the holder. Gently push the knife all the way in.
3. Turn the holder upside down and tap it lightly on a solid surface to ensure that the knife is completely inserted.
4. Slowly turn the knurled knob clockwise until the tip of the blade extends the distance required for the desired cutting media (t), as shown in the figure below.

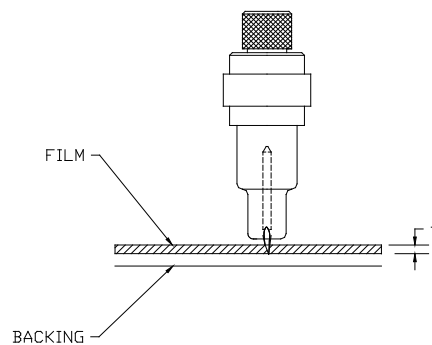

FIG 1-26  
KNIFE LENGTH ADJUSTMENT

5. Insert the knife holder into the rear (1) of the dual head clamp, seating it firmly.

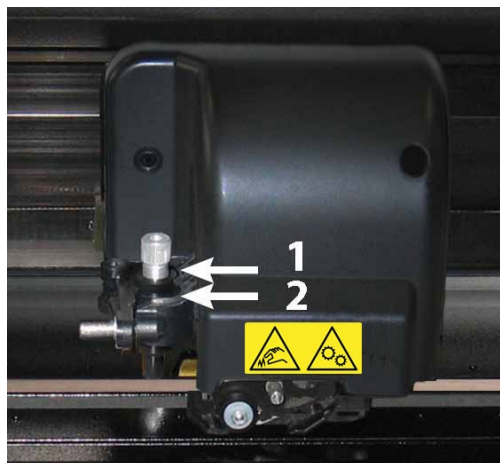

FIG 1-27  
DUAL CLAMP DRAG HEAD

6. Close the clamp and tighten the clamp screw.  
1 is the position for knife and pen.  
2 is the position for a pouncing tool (see section 1.7.1.3).

*Setting the knife depth and pressure:*

**WARNING:** Each keystroke can initiate an internal test or movement of the head or media. Keep fingers and other body parts away from the cutting area. There are hazardous moving parts.

1. Power on the cutter and load the media.



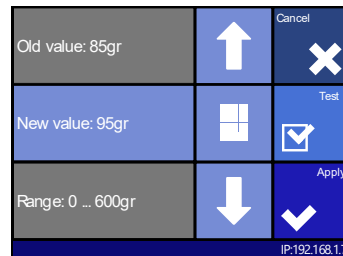

2. Press on pressure

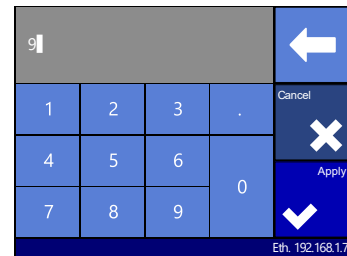

3. Press the arrow up or down to change the value.



4. Or fill in the new value after pressing Numpad.

1. Press  to perform the internal knife pressure test.
2. Press  to confirm the chosen knife pressure and exit the menu.
3. Press  to leave the pressure unchanged.

Once  is pressed, the current knife pressure value will be set automatically to the new value and the cutter will cut the knife pressure test pattern.

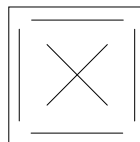

FIG 1-28  
KNIFE PRESSURE TEST PATTERN

Peel out the rectangle and inspect the media backing.

The knife depth is set correctly when the test pattern cuts completely through the vinyl, and the blade tip visibly scratched the front side of the media backing when the vinyl is removed. The blade should never cut in the backing but should only slightly scratch the silicon coating and first few fibers of the backing material. Because the knife pressure setting depends on the thickness and type of the media, adjusting the knife pressure will require some practice. In general, the knife depth must be increased when using thicker types of vinyl and decreased when using thinner types of vinyl.



**NOTE:** After setting the cutting depth and/or the knife pressure, perform a thorough visual check of the knife blade, protruding from the knife holder and test the cutting results on a scrap of vinyl media.



**WARNING:** Do not operate the cutter if the knife blade cuts through the media backing, as this will seriously damage the cutter's rubber cutting strip and the knife.



**NOTE:** For most vinyl cutting operations, the knife blade tip will be barely visible at the bottom of the knife tool. If the knife blade tip is clearly visible, then the cutting depth must be readjusted.

To prevent damage to the cutter, check the depth of the knife blade tip and the quality of the cut each time you load a different type of vinyl into the cutter.

### 1.7.1.2 Pen installation

The S CLASS 2 drag cutters can also be operated with a plotter-type pen. After replacing the knife with a pen, the cutter can be used as a plotter to draw draft plots of new or existing designs on paper.

1. Loosen the head clamp screw and swing the clamp arm back. Then remove the tool from the clamp.
2. Install the pen in the rear slot, close the clamp arm and tighten the clamp screw.
3. The change of tool can either be done on the touch panel with Summa Cutter Control (PC only) or with the cutting software.

Selecting the pen operation disables the knife offset correction and changes the pressure to “pen pressure.”



**NOTE:** The information on the touch panel shows the tool, which was currently selected by the cutter. Make sure the cutter's tool setting matches the actual tool in use.

### 1.7.1.3 Pouncing pin installation

The S CLASS 2 drag cutters can also be operated with a pouncing tool. After replacing the knife with a pouncing tool, the cutter can be used as a paper pouncer.

1. Loosen the head clamp screw and swing the clamp arm back. Then remove the tool from the clamp.
2. Install the pouncing tool in the front slot, close the clamp arm, and tighten the clamp screw.
3. The change of tool can either be done on the touch panel with Summa Cutter Control or with the cutting software.

Selecting the pouncing tool operation disables the knife offset correction, changes the pressure to “pouncing pressure” and will add “pouncing gap” to the tool properties.



**NOTE:** The information on the touch panel shows the tool, which is currently selected by the cutter. Make sure the cutter's tool setting matches the actual tool in use.



**CAUTION:** Before starting to pounce, check whether the pouncing tool is positioned above the black pouncing strip. If the pouncing tool is mounted in the rear slot of the clamp, the cutting strip will be damaged irreversibly!

## 1.7.2 Cutters with tangential head

### 1.7.2.1 Tangential knife installation

A knife is pre-installed in your cutter. For safety reasons, the knife depth has been set to zero. Simply turn out the knife (see fig FIG 1-29) to start cutting. Below is the complete description of how to remove or install a knife.



**NOTE:** To benefit fully from the advantages of the tangential knife, the amount the knife extends is very important. The knife pressure may not control the knife depth. The two rollers of the nosepiece should always touch the media, thus controlling the knife depth.

#### *Removing the tangential knife*

1. Turn the knife holder counterclockwise. The holder will rise up, eventually making it possible to lift the knife holder out of the tangential head. The nosepiece is situated underneath. Remove this part if another tool is used in the cutter.

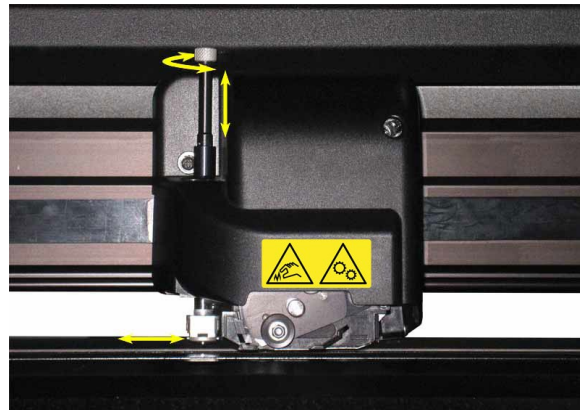

FIG 1-29  
REMOVING THE TANGENTIAL KNIFE HOLDER

2. The knife can be removed from the knife holder by using something like a flat screwdriver to pry in the groove between the knife and the knife holder.



FIG 1-30  
REMOVING THE KNIFE FROM THE TANGENTIAL KNIFE HOLDER

*Installing the tangential knife and setting the knife depth*

1. Insert the standard knife blade into the knife holder. Make sure the knife blade is firmly fixed in the holder. The knife is inserted correctly if it cannot be removed manually from the knife holder. The installation tool can be used to apply enough pressure on the knife in order to secure it.



FIG 1-31  
BLADE ASSEMBLY

2. Insert the nosepiece from the side until it snaps into place. Gently insert the knife into the tool shaft. Hold the nosepiece in place with one hand and, with the other hand, turn the knife holder counterclockwise until the alignment pin fits into the small notch of the tool shaft. Now turn the knife holder clockwise until its thread fits inside the tool shaft.

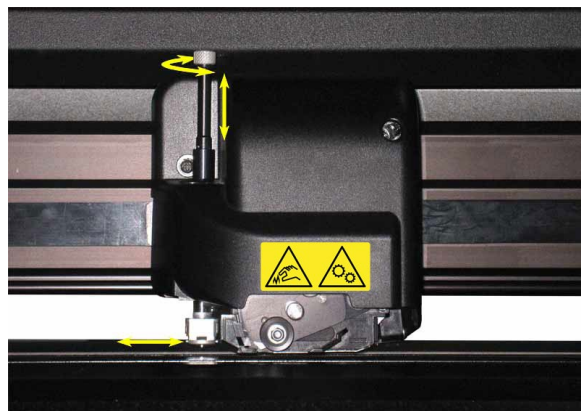

FIG 1-32  
INSERTING THE TANGENTIAL KNIFE HOLDER

3. Hold the nosepiece in place with one hand. Adjust the knife depth with the other hand by turning the knife holder clockwise until the knife tip is just visible from underneath the nosepiece.

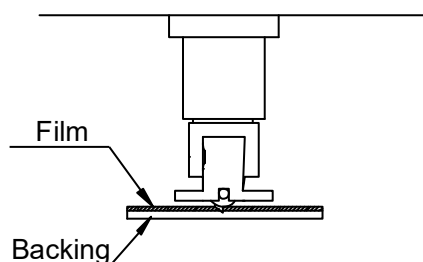

FIG 1-33  
KNIFE DEPTH ADJUSTMENT

**Setting the pressure and checking the knife depth:**

(the media must be loaded in the cutter before the knife pressure can be tested).



**WARNING:** Each keystroke can initiate an internal test or movement of the head or media. Keep fingers and other body parts away from the cutting area. There are hazardous moving parts.

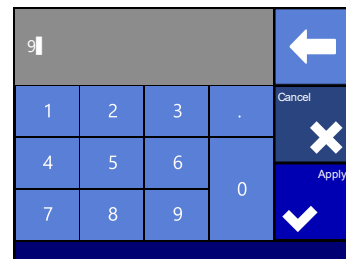
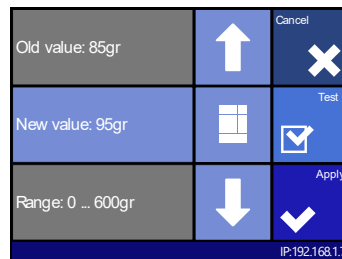
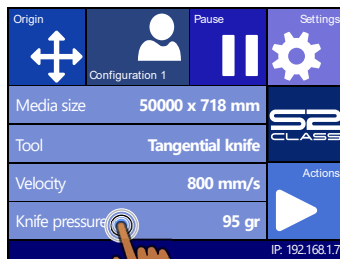

**1. Power on the cutter and load the media.**



**2. Press on pressure**

**3. Press the arrow up or down to change the value.**

**4. Or fill in the new value after pressing Numpad.**

1. Press  to perform the internal knife pressure test.
2. Press  to confirm the chosen knife pressure and exit the menu.
3. Press  to leave the pressure unchanged.

Once  is pressed, the current knife pressure value will be set automatically to the new value and the cutter will cut the knife pressure test pattern.

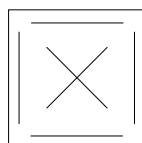

FIG 1-34  
KNIFE PRESSURE TEST PATTERN

Peel out the rectangle and inspect the backing.

The knife depth is set correctly when the test pattern cuts completely through the vinyl. The vinyl is removed and the blade tip visibly scratched the front side of the media backing. The blade should never cut through the backing but only slightly scratch the silicon coating and first few fibers of the backing material.



**NOTE:** The knife pressure can also be used to check the knife depth (which is controlled by the amount the knife extends out of the nosepiece). If the correct knife pressure is raised by 150 gr, then the knife should not cut through the backing of the vinyl. If it does, the knife depth needs to be reduced.



**CAUTION:** After setting the cutting depth and/or the knife pressure, perform a thorough visual check of the knife blade, which protrudes from the knife holder, and test the cutting results on a scrap of vinyl media!



**WARNING:** Do not operate the cutter if the knife blade cuts through the media backing as this will seriously damage the cutter's rubber cutting strip and the knife.



**NOTE:** For most vinyl cutting operations, the knife blade tip will be barely visible at the bottom of the knife tool. If the knife blade tip is clearly visible, the cutting depth must be readjusted.  
To prevent damage to the cutter, check the depth of the knife blade tip and the quality of the cut each time you load a different type of vinyl into the cutter.

### 1.7.2.2 Pen installation

The S CLASS 2 tangential cutters can also be operated with a ballpoint pen. After replacing the knife with a pen, the cutter can be used as a plotter to draw draft plots of new or existing designs on paper.

1. Turn the installed tool counterclockwise. The holder will raise, making it possible to lift the knife holder out of the tangential head. The nosepiece is situated underneath. Remove this part if it is mounted.
2. Gently insert the ballpoint pen holder into the tool shaft.
3. Turn the ballpoint pen clockwise all the way down.
4. The change of tool can either be done on the touch screen with Summa Cutter Control or with the cutting software.

Selecting the pen operation changes the pressure to “pen pressure.”



**NOTE:** The information on the touch panel shows the tool, currently selected by the cutter. Make sure the cutter's tool setting matches the actual tool in use.



### 1.7.2.3 Pouncing pin installation

The S CLASS 2 tangential cutters can also be operated with a pouncing tool. After replacing the knife with a pouncing tool, the cutter can be used as a pouncer.

1. Turn the installed tool counterclockwise. The holder will rise up, making it possible to lift the tool out of the tangential head. A nosepiece is situated underneath. Remove this part also if it is mounted.
2. Remove the black plug from the front tool shaft.
3. Gently insert the pouncer into the front tool shaft. Turn the pouncer clockwise, all the way down.
4. The change of tool can either be done on the touch screen with Summa Cutter Control, or with the cutting software.

Selecting pouncer operation changes the pressure to “pouncer pressure” and adds “pouncing gap” to the tool properties.



**NOTE:** The information on the touch panel shows the currently selected tool by the cutter. Make sure the cutter's tool setting matches the actual tool in use.



**CAUTION:** Before starting to pounce, check whether the pouncing tool is positioned above the black pouncing strip. If the pouncing tool is mounted in the rear slot of the clamp, the cutting strip will be damaged irreversibly!

### 1.7.2.4 Drag knife installation

The S CLASS 2 tangential cutters can also be operated with a drag knife. To set the properties for the drag knife, see section 1.7.1.1. Follow steps 1 until 4, and then continue with step 5 as follows:

1. Turn the installed tool counterclockwise. The holder will rise up, making it possible to lift the knife holder out of the tangential head. The nosepiece is situated underneath. Remove this part also if it is mounted.
2. Mount the nosepiece for the drag knife.
3. Gently insert the drag knife into the rear tool shaft. Turn the drag knife clockwise, all the way down.
4. The change of tool can either be done on the touch screen with Summa Cutter Control, or with the cutting software.
5. Selecting drag knife operation will add “knife offset” to the tool properties.



**NOTE:** The information on the touch panel shows the currently selected tool by the cutter. Make sure the cutter's tool setting matches the actual tool in use.

### 1.7.3 Replacement of the separation knife blade

The tool carriage also holds the separation knife. With this knife (razor blade), the job can be cut off automatically, after it is finished.



**NOTE:** This separation knife should only be used with standard vinyl (max 0.25mm thick).

1. Remove the razor blade holder by turning on the knurled screw at the bottom of the tool carriage.
2. The razor blade is kept in its place by a small magnet. Turn it around or replace it when it is worn down; figure 1-b.

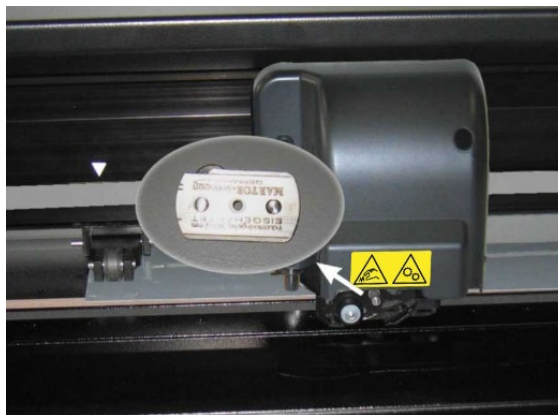

1-35

RAZOR BLADE FOR AUTOMATIC SEPARATION OF MEDIA



**NOTE:** The assembly is tilted under an angle of  $\pm 30^\circ$  when it is put back on the machine. Mind the position of the assembly before replacing the razor blade.

## 1.8 Activation of the barcode

Before the first use, the barcode function needs to be activated. The activation happens through our website (<https://www.summa.com/support/product-registration/>). The serial number of the cutter is needed for this activation. The serial number can be found on the serial number label on the back of the cutter or in the system setup menu. It is recommended to get the serial number directly from within the system setup menu.

*Step one: obtaining the serial number:*

Switch the cutter on

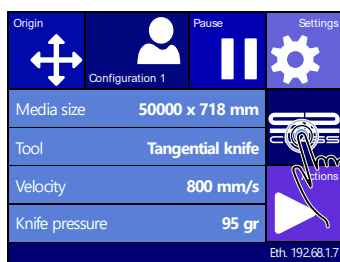

1. Press machine button

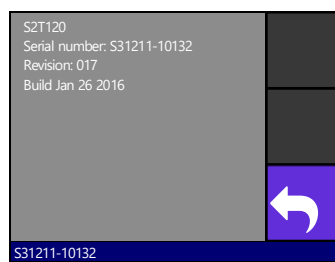

2. Write down serial number and press back.

*Step two activation of the barcode:*

- Go to the webpage and fill it out. The web page will show a 6 digit number which is the activation code. A mail will be sent with the serial number and activation code. Please save this mail for future reference.
- Power on machine.

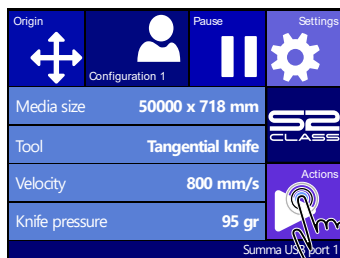

5. Press Actions

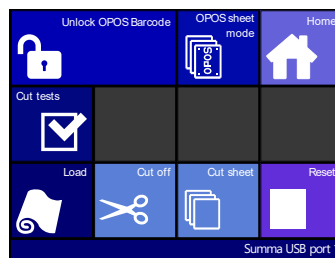

6. Press Unlock OPOSbarcode

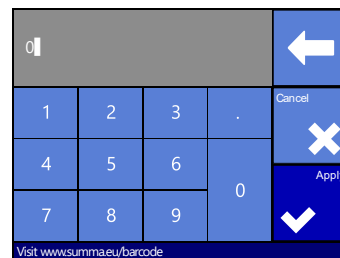

7. Set the value to the 6 digit number from the website and press Apply

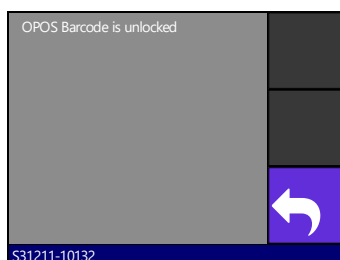

8. Press Back.



## 2.1 Touch Screen

The 320x240-dot touch screen provides a unique interface system that provides detailed cutter status information and offers a more flexible and powerful control of the cutter's configuration.

All screen and optional panel controls on the touch screen are easily formatted to allow quick access to the most common cutter settings.

Next to the status messages and/or menu options, displayed on the touch screen, button symbols can be pressed to change menu items or to change the value for a given submenu/parameter.

There are different color schemes to choose from.

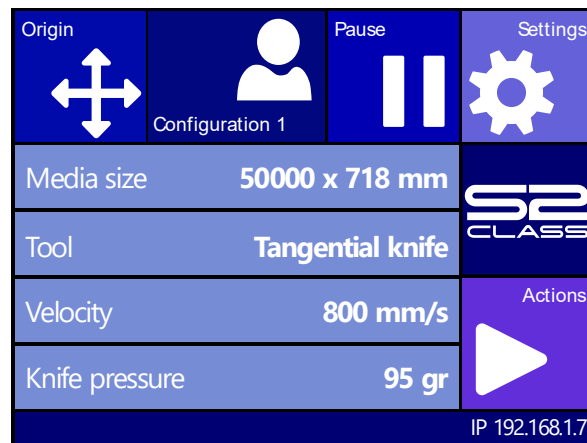

FIG 2-1  
TOUCH SCREEN

There is also a screen saving feature. After a certain amount of time the screen goes blank and this logo appears on the screen.



FIG 2-2  
SCREEN SAVER

If applicable tips or advice will be shown instead of the Summa logo. For example when the cutter is not busy and the pinch rollers are down, then following warning will appear on screen.

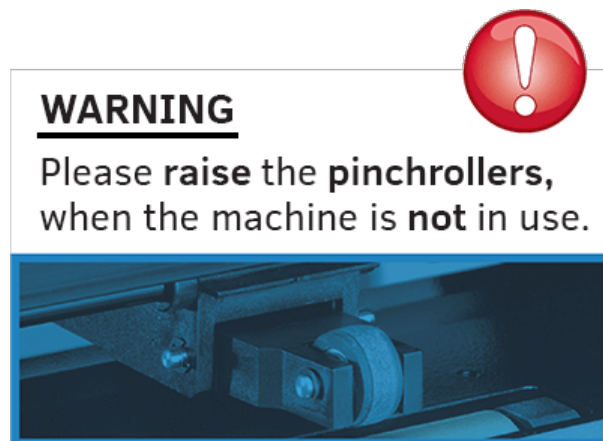

Touching the screen once disables the screen saver.



**WARNING:** Each keystroke can initiate an internal test or movement of the head or media. Keep fingers and other body parts away from the cutting area. There are hazardous moving parts.

## 2.1.1 Touch screen

The touch screen provides information and enables the user to change the cutter's parameters.

### *Most common buttons on the touch screen:*

Normally, the status or current value is visible on the left side of the screen, while the control buttons appear on the right side.

There are five main control buttons: , , ,  and .







If a menu is entered, 3 navigation buttons: ,  and  will appear.

Press  to return to the status screen. If media is loaded in the cutter, the cutter will come online and will be ready to cut a job, sent from the computer.

Press  for more menu/settings options. If there are more than six options for the chosen menu/parameter, pressing this button will reveal the rest of the options on screen.

Press  to return one step in the menu structure.

### *Other buttons that will appear on the screen are:*

, ,  and  arrow buttons to move the tool carriage or media or   to change the values of the parameters.

 to cancel an instruction or change a parameter.

 to apply a change in parameter.

 to initiate an internal test.

### *Status line:*

The bottom line gives extra information about the way how the cutter is connected to the computer.

If it is connected through the Ethernet connection, then the IP address is shown.

In other cases, the current USB class is shown.

When in menu mode, it shows which menu the machine is in.

## 2.1.2 Settings

The Settings button gives access to the main menu. Pressing this button will cause the cutter to go offline and suspend all operations in progress. The main menu contains all parameter settings, submenus and access to tests and calibration routines.

The chosen tool will influence the displayed settings.

**Parameter Settings** are recognized by the name of the parameter and the value. Press the parameter to change the value.

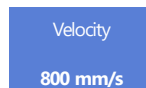

**Sub menus** are recognized by the group name followed by three points. Submenus group certain parameters. Access to some of the submenus will be determined by the plotting language or tool type.



**Tests & calibration routines** are recognized by the name of the test followed by a small start button. These offer access to the different internal tests and calibration routines. The calibration routines are used to adjust and fine-tune the cutter for the chosen application. The internal tests are used for diagnostics.

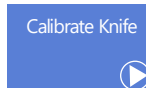

## 2.1.3 Actions







The "Actions" button is used to initiate a load sequence, abort the cut in progress, recut the last file, access the flash drive or cut an internal test.



## 2.1.4 Origin

1. Press .

*The origin menu will appear on screen*

2. Use the , , , and  to reposition the origin; press  to confirm or press  to leave without changing the origin.

3. Press  to cut off a previous job, if necessary. The cutter will then automatically search the front of the media and set the new origin.



**NOTE:** Check the position of the job before cutting off. If the job was ended correctly by the software, the distance between the new origin and the previous job is the value of the recut distance. This should be set to a minimum of 45 mm if the cut off button is used without moving the media first with the arrows.

## 2.1.5 Configuration

The S CLASS 2 cutters include 8 user configurations, all of which consist of the same parameters. Each configuration can have unique parameter settings. This allows the cutter to be quickly and easily reconfigured for different types of jobs or media.





**NOTE:** Factory default values for the different users are all set the same way.

1. Press .

*The different users will appear on screen.*

2. Press on the desired user or press  to view more.

3. Press  to confirm the new user.

4. Press  to leave the menu without changing the user.



**NOTE:** Use easy names in order to easily recognize what each user is configured to do. Commonly used names are: Normal, Pen, Slow, Sandblast, intermediate vinyl, etc.



**NOTE:** The touch screen can be used to change user configurations. User configuration names can only be modified with Summa Cutter Control (PC only).

## 2.1.6 Online/Pause

Online and pause are two important concepts when using the S CLASS 2 cutters. The cutter is online only when the status of the touch screen is similar to figure 2-3.

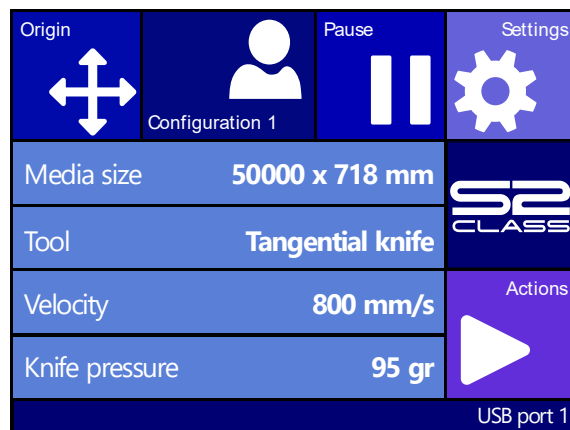

FIG 2-3  
ONLINE STATUS SCREEN

When online, the cutter can be controlled by the host computer, which means that the cutter will execute cutting or plotting instructions, issued by the host computer's application software. As soon as any other button on the cutter is pressed, the cutter pauses and can no longer be controlled by the host computer. However, if the computer was busy sending cutting data to the cutter it will be able to do so until the buffer of the cutter is full.

1. Press .
2. The tool can be moved around the working area with , , and .
3. Press to raise or lower the tool.
4. Press to set the cutter online again.

## 2.2 How to Set Tool Parameters

The S CLASS 2 cutters can work with a knife, pen or pouncer. With the T version you have the choice between drag knife and tangential knife.

Once a tool has been changed, the tool parameters (menu settings) must be reset or checked. All the different tools have one parameter name in common: the pressure.

Each tool also has its specific parameters.

Tool parameters can be changed by either changing them in the current user, or simply by changing the user (see section 2.1.5).



**NOTE:** The S CLASS 2 cutters will only perform according to specifications if a genuine Summa knife, pen or pouncing tool is installed. Do not replace the standard knife, pen or pouncing tool with products from other manufacturers.



**WARNING:** Each keystroke can initiate an internal test or movement of head or media. Keep fingers and other body parts away from the cutting area. There are hazardous moving parts.

### 2.2.1 Setting the tool type

1. Power on the cutter and load the media.

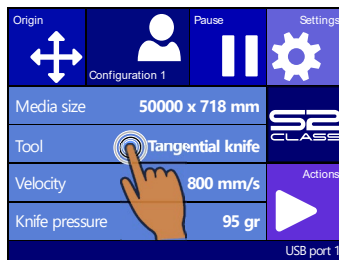

2. Press Tool

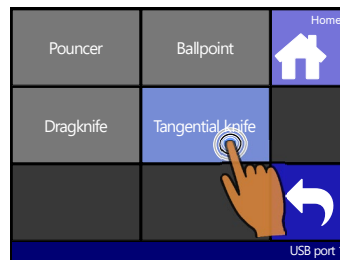

3. Select tool



4. Press Apply to select the tool that is highlighted on screen.

*The cutter will prompt the user to change the tool if the default tool has been changed.*





**NOTE:** If no media is loaded, then access the tool menu by pressing . The cutter will prompt the user after the media is loaded for a tool change if necessary.

## 2.2.2 Changing the tool pressure

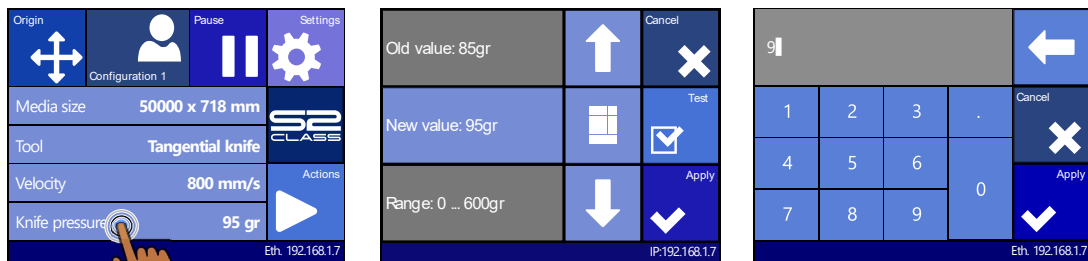
1. Power on the cutter and load the media.



2. Press on pressure
3. Press arrow up or down to change the value.
4. Or fill in the new value after pressing Numpad.

1. Press  to perform the internal knife pressure test.
2. Press  to confirm the chosen knife pressure and exit the menu.
3. Press  to leave the pressure unchanged.

## 2.2.3 Changing the drag knife offset

A very important parameter for a drag knife is the offset. The offset is the distance between the knife center and the knife tip.



**NOTE:** The knife offset should be set each time the knife is changed and should be checked if the knife shows signs of wear.





**NOTE:** A typical knife offset for Summa knives is between 0.41 and 0.45 for standard knives, between 0.9 and 0.97 for sandblast knives and between 0.49 and 0.52 for the 60 degree knife.

*Changing the knife offset:*

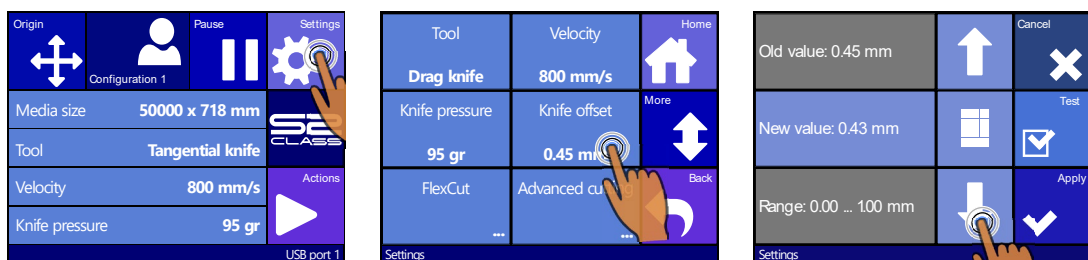
1. Power on the cutter, load the media and mount the drag knife (see section 1.7.1.1 or 1.7.2.4)



2. Press on Settings
3. Press on Knife offset.
4. Use arrows to change knife offset.

1. Press  to perform the internal knife offset test.
2. Press  to confirm the chosen knife offset and exit the menu.
3. Press  to leave the knife offset unchanged.

When the knife offset is set correctly, the test pattern looks like this:

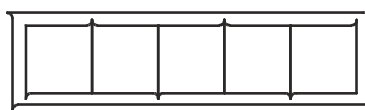

FIG 2-4  
CORRECT KNIFE OFFSET PATTERN

When the knife offset is too low, the test pattern looks like this:



When the knife offset is too high, the test pattern looks like this:



## 2.2.4 Calibrating a tangential knife

The purpose of the knife calibration routine is to detect and, if necessary, to correct problems related to the concentricity of the tangential knife blade.



**NOTE:** Knife calibration should be done each time the knife is changed and should be checked if the knife shows signs of wear.

Knife calibration errors may be due to any of the following causes:

- **Origin deviation.** The knife tip is slightly rotated in relation to its theoretical 0° angle. This error can be corrected by adjusting the origin.
- **Lateral deviation.** The knife tip deviates from its theoretical center in the lateral direction. This error can be corrected by adjusting the lateral parameter.
- **Longitudinal deviation.** The knife tip deviates from its theoretical center in the longitudinal direction. This error can be corrected by adjusting the longitudinal parameter.

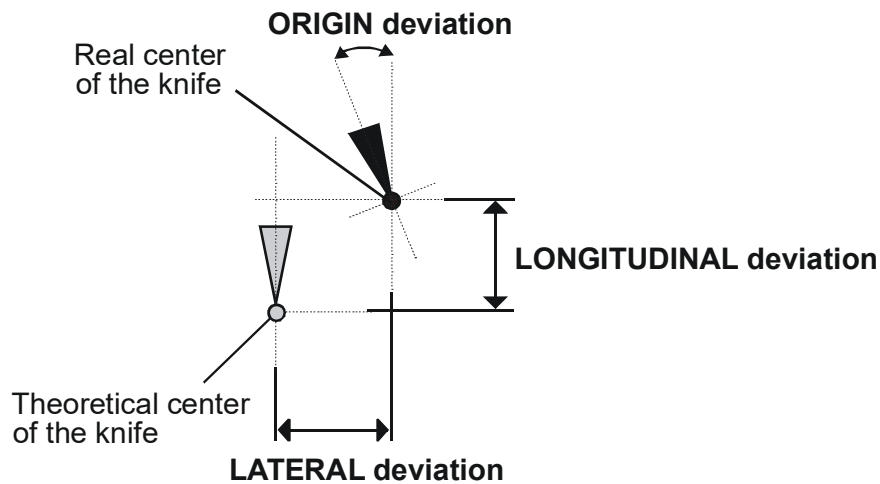
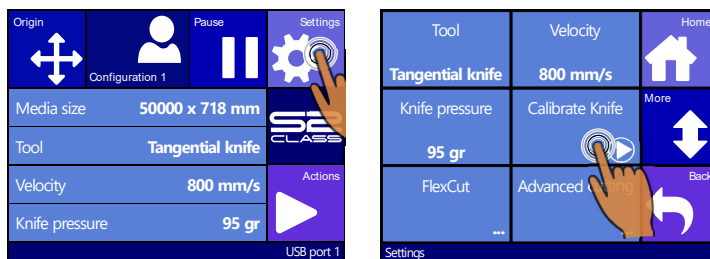

FIG 2-5  
POSSIBLE KNIFE CALIBRATIONS

During the knife calibration routine, the cutter will cut a series of test patterns which allow the user to identify errors in the knife rotation and concentricity. Use the touch screen to make corrections.



Setting tangential knife parameters:

1. Power on the cutter, load the media and mount the drag knife (see section 1.7.2.1.)





2. Press on Settings
3. Press on Calibrate knife.
4. Click on the parameter that needs to be changed.

The selected parameter will be highlighted in cyan on the touch screen.

5. Use   to change the value of the parameter.

The value (inverse) will change.

1. Press  to perform the internal knife calibration test.
2. Press  to confirm and exit the knife calibration menu.

When the knife offset is set correctly, the test pattern looks like this:

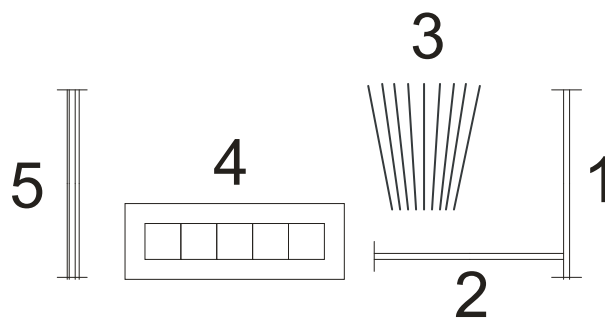

FIG 2-6  
CORRECT TANGENTIAL KNIFE CALIBRATION TEST

Rectangle 1 and 2 should weed out (remove) smoothly without sticking to the rest of the vinyl.

The fan-shaped pattern 3 should have a clear cut line in the middle; the ones at the sides show burs.

The squares in 4 should be aligned and equal in size.

The 4 vertical cuts in 5 should be clear without any burs and straight all the way from top to bottom (not rounded near the horizontal lines).



**NOTE:** It is possible not all test patterns come out perfectly (this depends on the type of vinyl). Test pattern 1 and 4 are the most important test patterns. They should be as close to perfect as possible. Start with the setting of the origin, and then set the other parameters.

#### *Origin correction*

If the clear cut line in test pattern 3 is located too much to the right, increase the value of the origin. Begin in steps of 20, and lower the steps when nearing the correct origin setting. It helps sometimes to gently feel the pattern to find out which side has the clear cut line.

If the clear cut line in test pattern 3 is located too much to the left, decrease the value of the origin. Begin in steps of 20, and lower the steps when nearing the correct origin setting.

#### *Lateral correction*

Weed out (remove) the rectangle in pattern 1 and in pattern 4. If the test pattern looks like the one below, decrease the value of the lateral parameter to correct the closing cut lines.

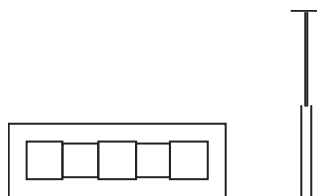

However, if the test cut resembles the pattern below, increase the value of the lateral parameter to correct the closing cut lines.

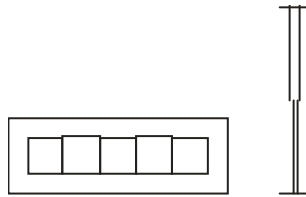

#### *Longitudinal correction*

Weed (remove) out the rectangle and, if you obtained a pattern like the one below, decrease the value of the longitudinal parameter to correct the closing cut lines.



However, if the test cut resembles the pattern below, increase the value of the longitudinal parameter to correct the closing cut lines.



Each time a parameter is changed, press  to perform the internal knife calibration test.



**NOTE:** Failing to set the knife parameters correctly will result in poor cut quality.



## 2.3 How to set the cutting speed

The actual speed at which the tool moves is determined by 4 different parameters. Speed (and acceleration) while the tool is down; speed (and acceleration) while tool is up.

These 4 parameters have been bundled in one parameter to change the speed fast and easily. This overall parameter is called “velocity” and is the speed the cutter uses when the tool is down. If velocity is raised or lowered, then the other parameters are also raised or lowered accordingly.

There is one fixed speed: the speed at which the cutter pulls the media from the roll. This speed is fixed at 200mm/s (8ips).

*Setting the cutting speed:*

1. Power on the cutter.

*In case the media is loaded:*



2. Press Velocity

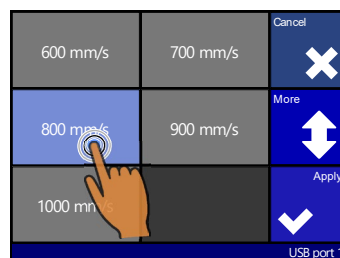

3. Select new velocity, scroll with More, if necessary.

*In case media not loaded:*

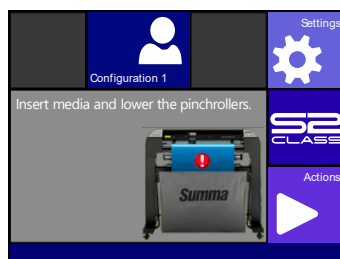

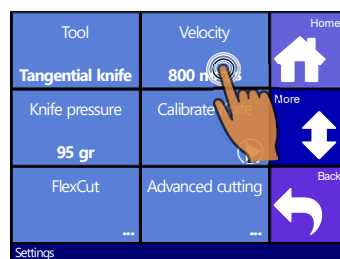

1. Press Settings

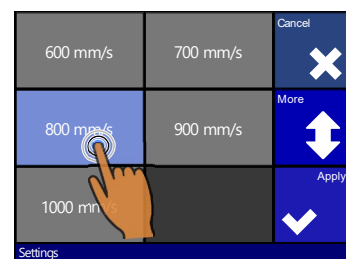

2. Press Velocity



3. Select the new velocity, scroll with More, if necessary.

Press  to confirm the chosen knife offset and exit the menu, press  to leave the knife offset unchanged.



**NOTE:** Sometimes the cutter feeds the material too fast and the media has no time to settle and fold into the basket. A fifth speed parameter is designed for such cases. The speed of long X-axis vectors is reduced automatically so that the media does not bulge (see section 4.3.1.8 **Long Vectors:**).

## 2.4 How to make sure the sign has the correct size (Length Calibration)

The S CLASS 2 cutters are friction-feed machines. This means that the cutting length depends on the thickness of the material.

The cutters have been calibrated in the factory for standard 2-mil cast or 3-mil calendared vinyl. Each user (the S CLASS 2 has a total of 8) can hold a different calibration factor. This is very helpful for multi-colored signs. It ensures that the parts in different colors match up, even if different types of vinyl media are used.



**NOTE:** For standard use, it is not necessary to calibrate the machine. With standard vinyl the accuracy is within 0.2%. However, if high accuracy between different vinyl or colors is needed, then calibration is necessary.

*Calibrating the media (Length calibration):*

1. Power on the cutter, load the media, and mount the knife (see section 1).



**NOTE:** The wider and longer the loaded media, the more accurate the calibration will be. Use a piece of vinyl of maximum width and a length that is approximately 1.5 times the width.

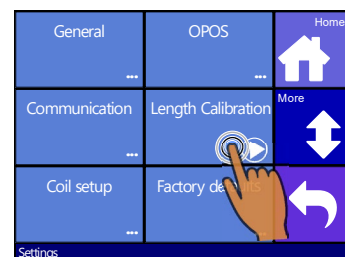
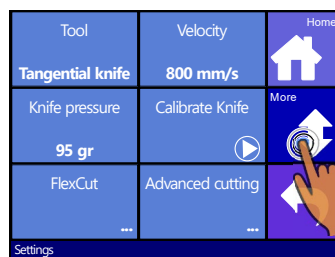
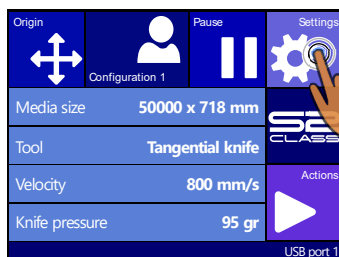

2. Press Settings
3. Press More
4. Press length calibration.

*The cutter will reload the media and perform the length calibration test. Take out the media and measure the length of the cut line with a ruler (measuring device). The length that has to be entered is the distance between line 1 and line 2 as shown in the figure below.*



FIG 2-7  
LENGTH CALIBRATION PATTERN



**NOTE:** The cutter will only be as accurate as the accuracy of the calibration itself. If the ruler (measuring device) is inaccurate, then re-calibrating may worsen the cutter's accuracy. The accuracy of the calibration will be reflected directly in the cuts. Set the cutter to Metric to do the calibration. It is more accurate than the English unit system (see section **Menu Units:**).

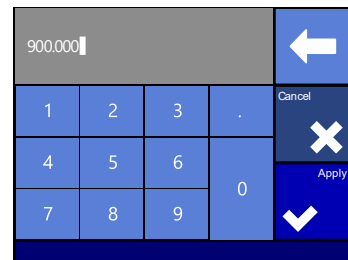
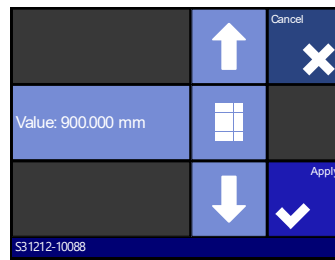
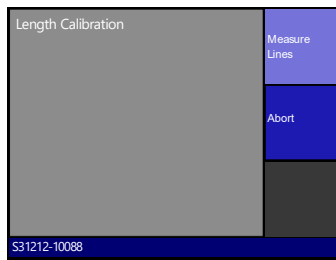

5. Press Measure lines to fill in the value or Abort without changing.

6. Use the arrow to change the value or press Numpad to fill in the value

7. Delete the numbers with the arrow, press Apply to confirm the value.

8. Press  to confirm the value of the measured length.



**TIP:** Once this user is calibrated, change the user name. This makes it easy for future reference.

## 2.5 Cutting through

### 2.5.1 Procedure

The cutting through functionality is focussed to cut simple shapes (e.g. rectangles). It is most used in combination with contour cutting.

An interrupted cutting line makes sure that the material remains together thanks to the small media 'bridges'. When the job is finished the cut pieces can be torn loose.

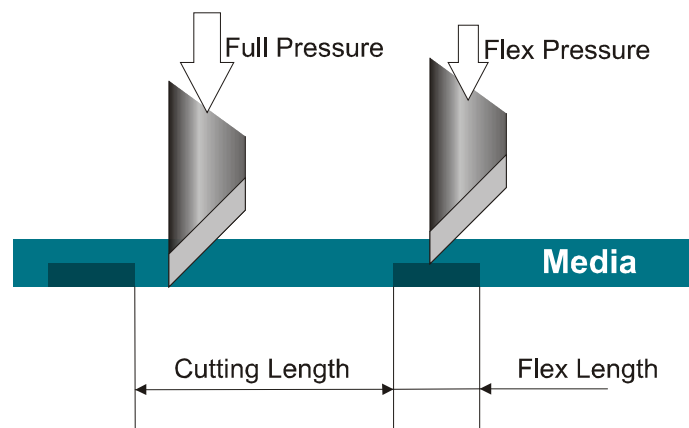
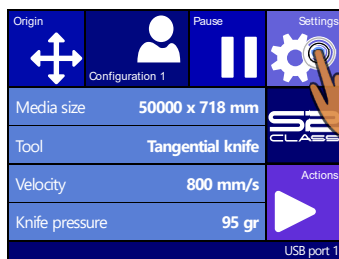

FIG 2-8  
FLEXCUT PRINCIPLE

Some cutting software can recognize the difference between a contour line and a cut-through line. The software first sends the data of the contour lines to the cutter and then activates FlexCut, paneling mode and vector sorting and sends the cut-through data to the cutter. If the cutting software cannot do this, the user needs to send the data of the contour lines separately, set the cutter in FlexCut mode manually and then send the cut-through data

*Setting the parameters for cutting through the media:*



1. Press Settings.

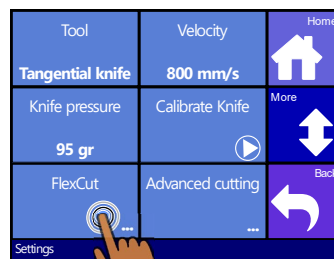

2. Press FlexCut.

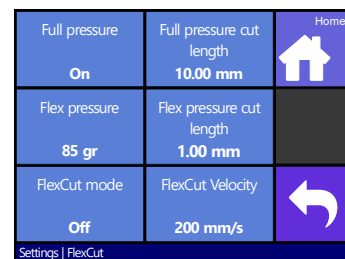

3. Select the parameter to change.

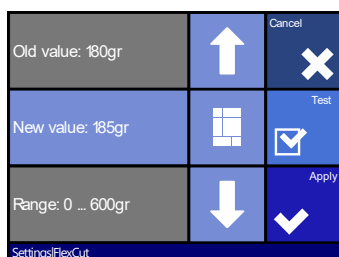

Press the arrows or use Numpad to change the Full pressure and press Apply to confirm.

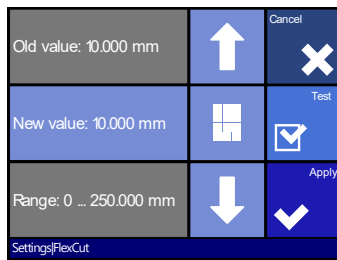

Press the arrows or use Numpad to change the Full pressure cut length and press Apply to confirm.

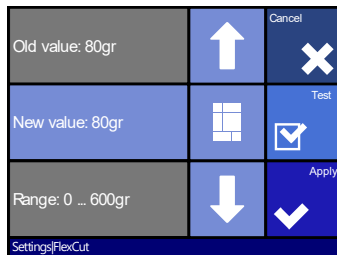

Press the arrows or use Numpad to change the Flex pressure and press Apply to confirm.

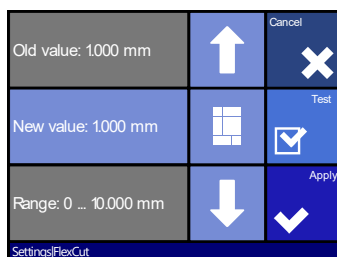

Press the arrows or use Numpad to change the Flex pressure cut length and press Test to confirm.

*The cutter will cut out a test pattern.*

4. Check if the result is satisfactory. If not, change one of the above 4 parameters. Reducing the velocity can also improve the result. It is never recommended to use cutting speeds larger than 400mm/s (16 ips) with cutting pressures above 200 gr.



**ATTENTION:** It is difficult to give recommended settings for FlexCut. Check section 2.5.2.3.





**NOTE:** When cutting through, it is recommended that parallel lines are at least 1 cm away from each other. Otherwise, while cutting the second line, the first line may come loose and cause trouble.



**NOTE:** FlexCut parameters are always metric, regardless the value of the panel Units parameter.



**NOTE:** FlexCut can be set off or on for older types of software that cannot switch FlexCut on or off. It is recommended to only use the accurate mode.

5. After that press  to get in the FlexCut menu and then press 



6. Press Advanced cutting.

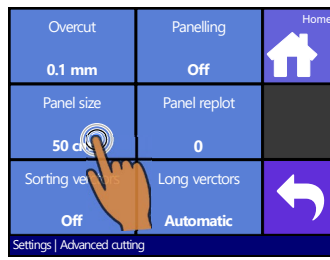

7. Press Panel size.

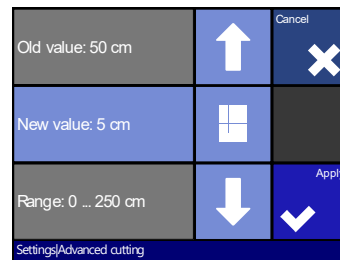

8. Use the arrows or Numpad to change to value (between 3 and 10 cm) and press Apply.

9. Press  to set the cutter online again.



**NOTE:** The above procedure has to be done even if the software on the computer can activate FlexCut. It is also recommended to set the FlexCut parameters on the cutter and not with the cutting software.

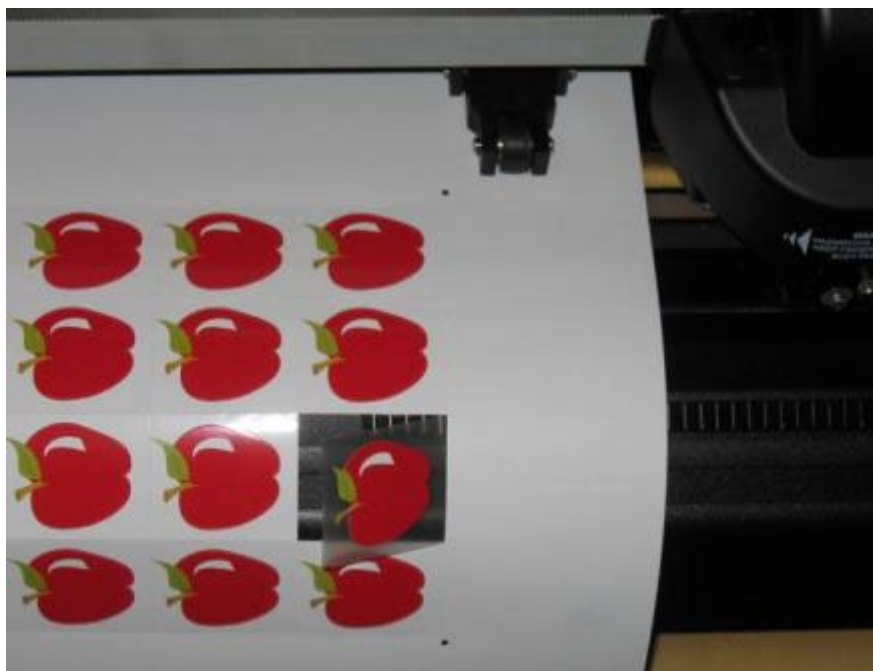

FIG 2-9  
COMBINED CONTOUR CUT AND CUTTING THROUGH

## 2.5.2 Practical tips

### 2.5.2.1 Physical knife depth tangential knife

Although very similar, there are two types of knife depth settings, one for normal cutting and one for when FlexCut is used. What they have in common is that the knife is never turned out a lot.

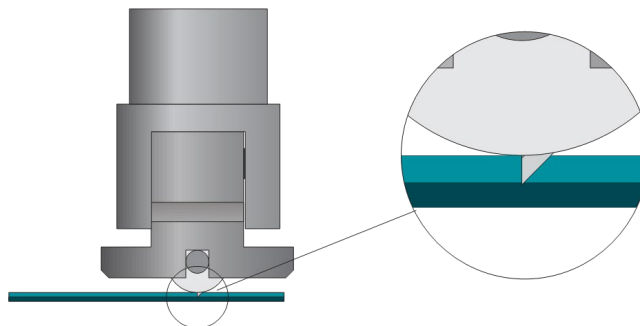

FIG 2-10  
KNIFE DEPTH SETTING NORMAL CUTTING

For normal cutting the knife is turned out just a little bit more than the actual cutting depth, so the knife tip just scratches the backing. Turning out the knife much further results in unstable knife pressure and bad cutting quality.

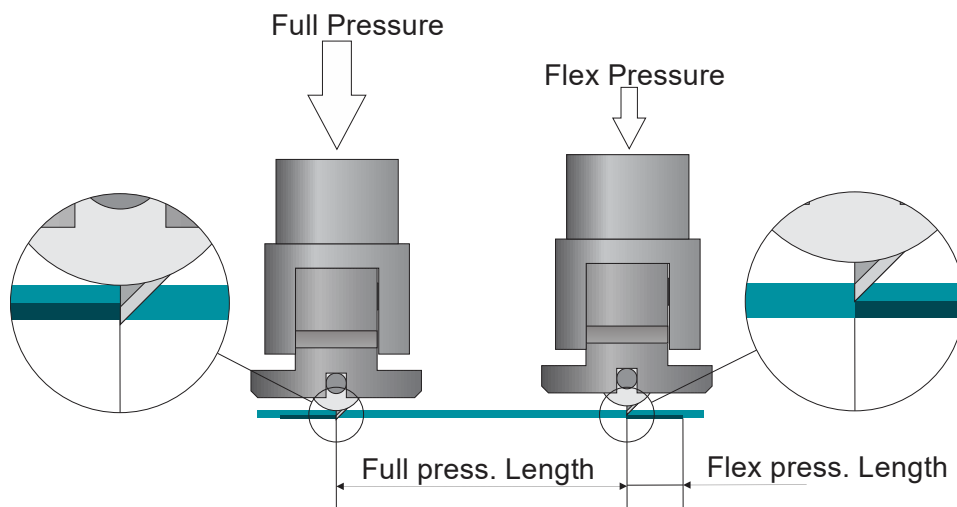

FIG 2-11  
KNIFE DEPTH SETTING CUTTING THROUGH

When performing FlexCut the knife is turned out just enough to cut through the vinyl and backing. It is recommended to let the nose piece touch the media at full pressure.

## 2.5.2.2 Physical knife depth drag knife

Although very similar, there are two types of knife depth settings, one for normal cutting and one when FlexCut is used. What they have in common is that the knife is never turned out a lot.

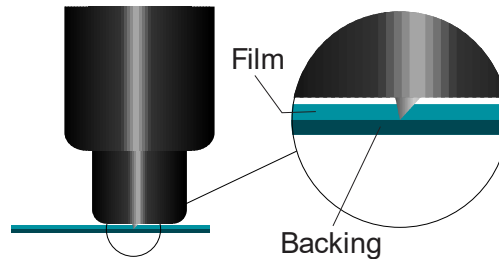

FIG 2-12  
KNIFE DEPTH SETTING NORMAL CUTTING

For normal cutting, the knife is turned out just a little bit more than the actual cutting depth. Turning out the knife much further results in unstable knife pressure and bad cut quality.

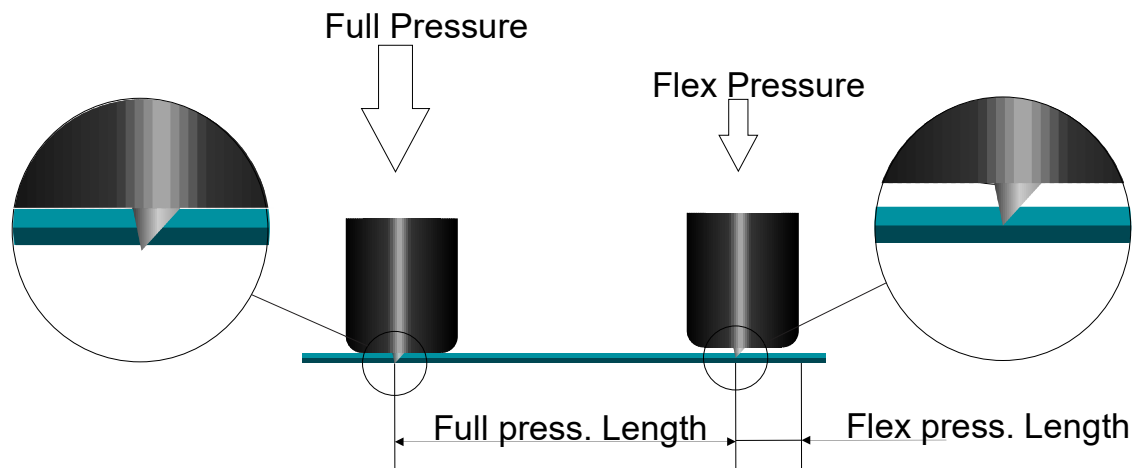

FIG 2-13  
KNIFE DEPTH SETTING CUTTING THROUGH

When performing FlexCut the knife is turned out just enough to cut through the vinyl and backing. The decision to let the knife holder rest on the media at full pressure depends on the actual media you are using. If the media is prone to scratching, then make sure the bottom of the knife holder does not touch the media when using full pressure. If not, it is recommended to let the bottom of the knife holder touch the media at full pressure.



### 2.5.2.3 Values of the FlexCut parameters

Determining the values of the FlexCut parameters can be divided into two main steps. The first step is to determine the 'fixed' pressure values. The second step is determining the length parameters empirically.

#### *Step 1*

First go to the knife pressure test as described in section 2.2.2. Determine the pressure, needed to cut completely through both vinyl and backing. Make sure the pressure is not set too high and the knife is not turned out too far.

After the needed pressure is determined, raise the knife a little bit to check if it still cuts completely through. If this is the case, do this again. If it does not cut completely through, then turn the knife out as it was.

Now lower the knife pressure a little bit to check if it still cuts completely through. If this is the case, lower it again a little bit. If it's not the case, set it at the previous value.

This is how the correct pressure to cut completely through the media is determined. Also the correct amount to turn out the knife is determined the same way.



**NOTE:** Write down the pressure, needed to cut completely through and do not change the physical knife depth anymore (unless the knife has worn down a little bit).

Now, lower the knife pressure correctly to cut just through the vinyl. Also write down this value.

#### *Step 2*

Go to the FlexCut parameter setting menu as described in section 2.5.1. Set the full pressure parameter to the value that was needed to cut completely through the media (determined in step 1) and set the FlexCut pressure to the value needed to cut just through the vinyl.



**NOTE:** It is never recommended to use cutting speeds larger than 400 mm/s (16 ips) with cutting pressures above 170 gr. So, if the full pressure is larger, lower the FlexCut velocity.

Now go to the full pressure length parameter and set this to 10 mm. Go to the FlexCut pressure length and set this one to 0.8 mm. Perform a test. Check the bridges. If they are too large, perform a test with a lower value. If they are too small (or none-existent) then raise this value.

The FlexCut parameters are now set.

If these settings need to be adjusted, try by only changing the FlexCut pressure length. There is no need to adjust pressure settings, unless the knife wears down. In that case start again with step 1.



**NOTE:** It is not always easy to find the correct balance between cutting deep enough and making sure the pieces can be taken out easily and not cutting too deep, making sure the material keeps its strength while cutting. Sometimes this balance doesn't exist, meaning that this material can't be cut through with satisfactory result.

#### 2.5.2.4 Material without a backing

Although FlexCut was designed for usage with standard vinyl (typical two layered material), it is also used with single layered material.

In this case the settings of the parameters are more difficult and require more trial and error tests than calibrating FlexCut for normal vinyl.

The only parameter that can be determined easily is the full pressure.

The FlexCut pressure is very material depended. Plastics need a relative high FlexCut pressure. Fibrous material then needs relative lower FlexCut pressures.

The FlexCut pressure length of plastic substrates is then relatively short, whereas fibrous substrates need longer 'bridges' to keep the material together in order to move it back and forth.

However, the principle is the same. The parameters need to be set this way, so the bridges are strong enough to be able to move the material back and forth. But the bridges need to be small enough, so they are practically invisible once the object is removed from the material.

A secondary help might be the adjustment of the panel size. With very weak material, lower the panel size.

Overall, the parameter setting for single layered material takes a bit more time to set correctly.

## 2.6 Dual Head (Optional)



### 2.6.1 Introduction

As an option, the S Class 2 T Series can be equipped with a cutting head with dual functionality. This special Dual Head features an extra pen adaptor, instead of the OPOS sensor, allowing you to work alternately with each tool. This extra pen has a fixed pressure which is controlled by a spring.



FIG 2-14  
DUAL HEAD



**ATTENTION:** The universal pen holders (   ) cannot be used in the extra pen holder. Trying to mount them will break the pen holder.

### 2.6.2 Calibration Dual head

The extra pen needs an extra calibration. The purpose of the calibration is to set the origin point of the knife the same as the origin point of the extra pen. The parameter that controls this is called the Pen offset (X and Y).

Procedure to do this calibration:

1. Power on the cutter, load the media, and mount the knife and pen.

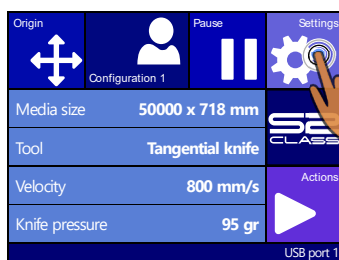

2. Press Settings

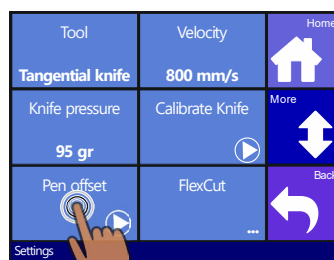

3. Press Pen offset

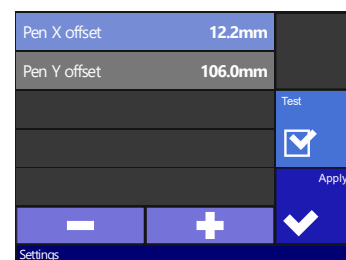

4. Press Test.

*The cutter will cut two small lines at an angle of 90° and then draw over those lines with the extra pen. If the pen draws exactly over the cut lines, then the Pen offset is calibrated correctly. If the lines are not drawn exactly over the cut line, then adjust the values and test again until the lines are exactly above one another.*

## 2.6.3 Settings in the cutting software

### 2.6.3.1 Using GoSign

When GoSign is used to send the cut data to the cutter, you need to use either colours or layers to determine which tool will be used for a particular cut line. Summa provides templates and swatch libraries for Illustrator and colour palettes for Corel. If not available use a colour named Draw or give the layer as name Draw. In GoSign link the name Draw to the extra pen tool. If necessary GoSign can be set up so that other names of colours and templates can be linked to the extra pen tool.

The order in which the tools are used is set with GoSign.

### 2.6.3.2 Other software

Other software refers to the extra pen as the 'extra pen' or as 'pen 4' (P4 or SP4). In other software it is usually possible to set the order of the tools as needed.

### 3.1 Introduction

Contour cutting is made possible by the S Class 2's highly accurate Optical Positioning System (OPOS).

The OPOS sensor, which is mounted on the right-hand side of the tool carriage, registers printed squares that are placed around the graphic. Because of this registration process, OPOS can determine the exact position of the printed graphic.

The sensor drops automatically while registering the marks and rises again after completing this task. The improved sensor can read virtually any kind of media-mark combination.



**NOTE:** The T4 S Class models use a USB camera instead of the OPOS sensor for registering the OPOS marks. Section 3.5.2 describes the differences between the sensor OPOS and the OPOS CAM.

### 3.2 Basic OPOS operation

In general, contour cutting includes the following steps:

1. Create the graphic and contour cut line(s).
2. Print the graphic using a RIP that supports Print & Cut (lamine afterwards if necessary).
3. Load the graphic into the cutter.
4. Load the media and register the marks.
5. Cut the graphic.

Many versions of cutting software have the built-in capability to make contour cutting user-friendly and automatic. Please refer to the user's manual that came with your software or contact your software dealer for specifics.



**NOTE:** Some RIP software requires that the contour lines are defined in a special colour (spot colour). Please refer to the user's manual that came with your software or contact your software dealer for specifics.



**NOTE:** Do not place contour lines along the edges of graphics or the slightest movement in the media may result in an unsatisfactory cut. Instead, practice one of the following techniques.

1. Place contour lines just inside the graphics.
2. Place contour lines outside the graphics.
3. Create thick borders around graphics and place contour lines inside these borders.

### 3.2.1 Printing the graphic

Print the graphic and its marks with a printer. When printing on a roll, make sure there is a 2 cm (0.8 in) margin at the sides and the front. For shorter jobs the edge margins might be smaller, but should be at least 1 cm (0.4 in).

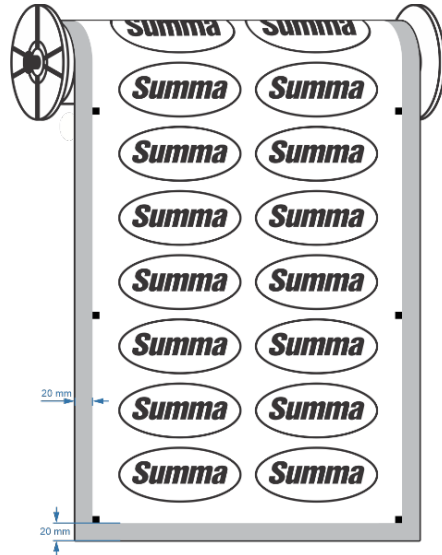

FIG 3-1  
MARGINS PRINTING ON A ROLL

When printing on a sheet, then there should be at least 40 mm of media after the last OPOS mark (this is also the minimum media that should be left at the end of a roll).

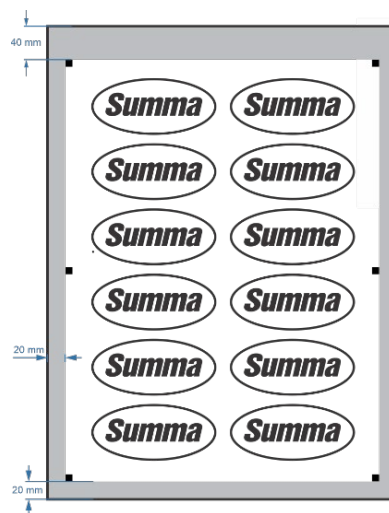

FIG MARGINS PRINTING ON A SHEET

### 3.2.2 Different OPOS alignment methods

This parameter, although it is an internal parameter, should be set in the print and cut software. Following options are usually available:

OPOS X: A row of marks is printed at the left and right side of the graphic. These marks are read by the OPOS sensor and then used for compensating printing deformation.

OPOS XY: An extra line at the bottom of the job is printed (line ① in the figure below), the sensor reads it and can also compensate for deformations along the width of the machine.

OPOS XY2: Analogue to the bottom XY line, a line (line ② in the figure below) is printed at the top of the job for cutting large jobs more accurately.

OPOS XYXtra: Analogue to the bottom XY line, a line is printed between each left-right mark.

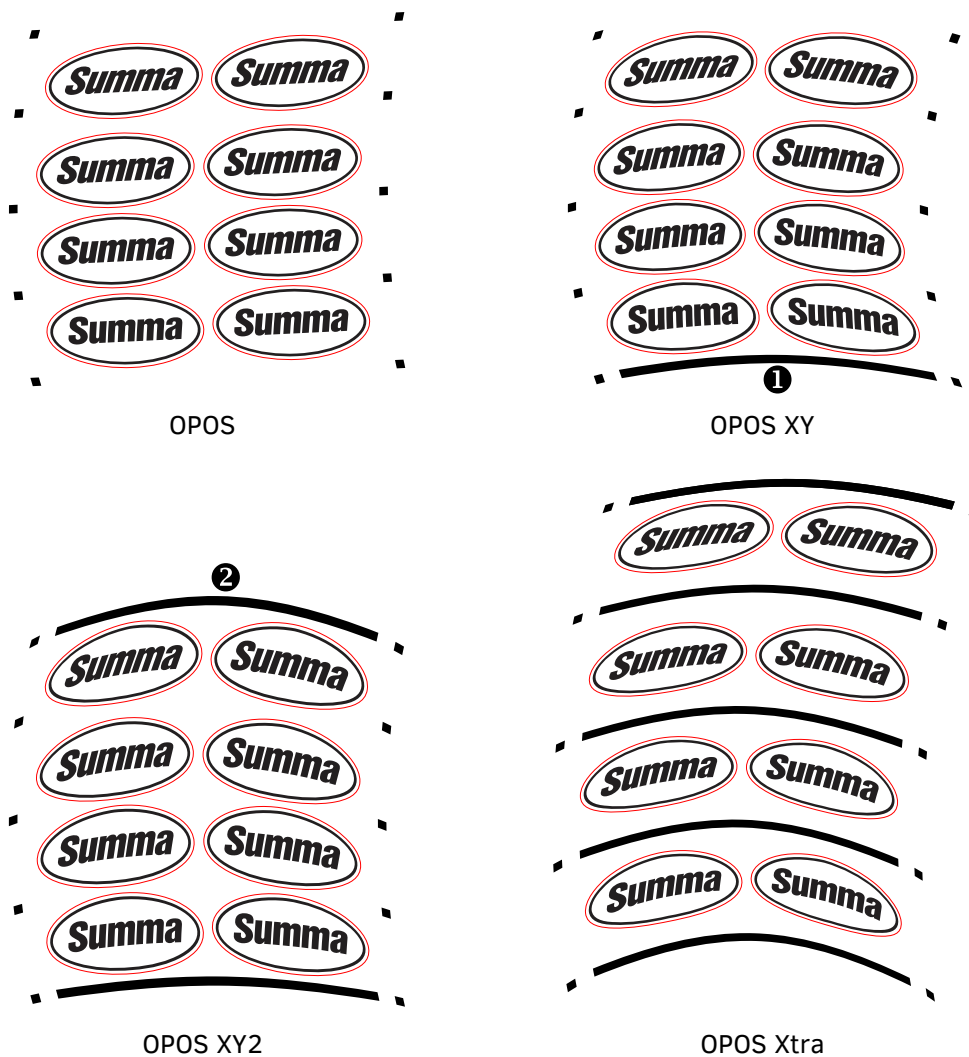

FIG 3-2  
OPOS ALIGNMENT METHODS

### 3.2.3 Processing long jobs

Normally the OPOS sensor registers all the marks before it starts cutting. However, with long jobs that can result in extensive back and forward feeding of the media, this could result in bad tracking. To avoid this, an extra parameter can be set in the cutter. With this option, the job can be divided into panels to avoid moving the media unnecessarily. When OPOS panelling is activated, all cut data will be cut in panels. The size of the panel will be the distance between the OPOS marks in the X-axis.

OPOS Panels can be set to OFF, ON (2 marks) or ON (4 marks). When set to ON (2 marks), the cutter will only load 2 marks in the X-direction when loading OPOS and read the marks (4 in total for the first panel). The following panels will then be cut after reading the marks at the end of that panel (so 2 for each following panel). When set to ON (4 marks), the last marks of the previous panel are re-read. This improves the connection between the panels.



**NOTE:** Do not use software panelling when using OPOS panelling.

Activating OPOS panelling:

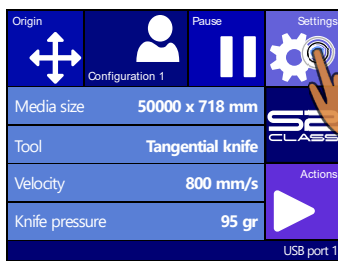

1. Press Settings



2. Press More

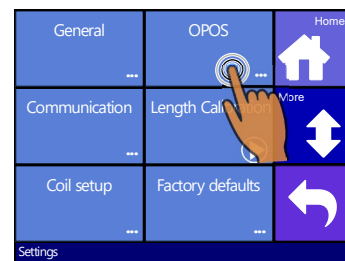

3. Press OPOS.

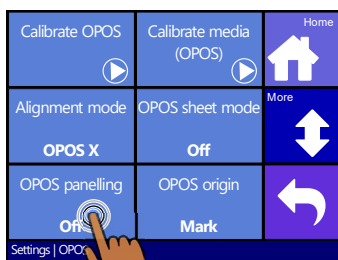

4. Press OPOS panelling.

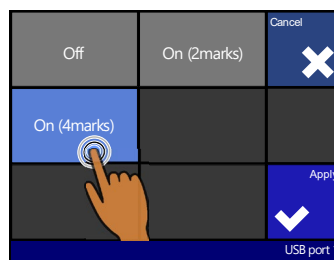

5. Press and then Apply.



### 3.3 Automating OPOS tasks

For standard OPOS jobs, the user only needs to set the tool above the first mark to start the job. OPOS allows the user to automate certain tasks, thus reducing user intervention and production time. There are several types of automation.

#### **Automatic start of the OPOS job**

This is controlled by the parameter OPOS origin. With a combination of this parameter setting and/or a special origin setting during the load of the media, the user doesn't have to set the tool above the first mark to start an OPOS job.

#### **Multiple copies of the same job**

When cutting multiple graphics, the user only needs to manoeuvre the OPOS sensor above the origin mark of the first graphic. Cutting subsequent graphics does not require additional user input.

There are two multiple-job situations in which OPOS can be used:

1. When cutting multiple (copies of a) graphic(s) on the same media roll.
2. When cutting the same graphic on multiple media sheets.

Most automated tasks are organized from within the cutting software. However, when the same graphic contour needs to be cut out, the automatic tasks may also involve some manual manipulation.

#### **Unattended contour cutting (roll to roll)**

A special barcode can be printed together with the job. This barcode can then be used to access the correct cutting data, so the cutter can cut one job after another without user intervention.

### 3.3.1 OPOS origin

The parameter OPOS origin is created to automate the start of the OPOS procedure. This parameter has 4 settings (Mark, Current Position, XY Line or Media centre). The usage of this parameter depends on the chosen OPOS mode.

This parameter is ignored when OPOS Sheet mode is activated.

#### 3.3.1.1 In combination with OPOS X mode

##### *The OPOS Origin is set to 'Mark'.*

This is the default setting. Upon receiving an OPOS job from the computer, the cutter will prompt the user to set the tool above the first mark and press Apply. The cutter will then start searching for the OPOS mark around that position.

##### *The OPOS Origin is set to 'Current position'.*

Upon receiving an OPOS job from the computer, the cutter will immediately start looking for the mark when it receives an OPOS job from the computer, without waiting for the user to move the tool. Therefore, the user will have to set the tool above the first mark while loading the material.



**NOTE:** If the OPOS origin is set to either 'XY-correction line' or 'Center of media', then the cutter will react as if the parameter was set to 'Mark'.

#### 3.3.1.2 In combination with OPOS XY, OPOS XY2 or OPOS Xtra mode

##### *The OPOS Origin is set to 'Mark'.*

This is the default setting. Upon receiving an OPOS job from the computer, the cutter will prompt the user to set the tool above the first mark and press Apply. The cutter will then start searching for the OPOS mark around that position.

##### *The OPOS origin is set to 'XY line'.*

Upon receiving an OPOS job from the computer, the cutter will prompt the user to set the tool under the OPOS XY line and press Apply. The cutter will then start searching for the OPOS XY line by slowly moving forward the media. Once it has found the OPOS XY line, it will follow this line to the right until it finds the first mark and will then start searching for the actual mark.

##### *The OPOS origin is set to 'Current Position'.*

Upon receiving an OPOS job from the computer, the cutter will immediately start searching for the OPOS XY line by slowly advancing the media. Once it has found the OPOS XY line, it will follow this line to the right until it finds the first mark and will then start searching for the actual first mark. Therefore, the user will have to set the origin under the OPOS XY line, immediately after the media has been loaded.

This setting was created for jobs that are aligned at the left side and differ a lot in size on the roll. The origin/tool can then be set to the left of the media, under the OPOS XY line to be able to find the origin mark, even if it is situated far from the right side of the media.

***OPOS origin is set to 'Media centre'***

Upon receiving an OPOS job from the computer, the cutter first sets the OPOS sensor in the middle of the media. Then it will start searching for the OPOS XY line by slowly moving forward the media. Once it has found the XY line, it will follow the XY line to the right until it finds the first mark and will then start searching for the actual mark.

This setting has been created for jobs on a roll where the width of each job is at least half the width of the media (this is usually the case; otherwise there are lots of wasted media). This method is slightly slower than the previous method.

**3.3.1.3 In combination with OPOS Barcode*****The OPOS Origin is set to 'Mark'.***

This is the default setting. Upon receiving the command to start reading the barcode (from the computer or from the touchscreen), the cutter will prompt the user to set the tool under the barcode line. The cutter will then scan the line at two points to determine the angle of the printed line. Then the head will go to the right pinch roller and start scanning the barcode.

***The OPOS origin is set to 'XY line'***

Upon receiving the command to start reading the barcode (from the computer or from the touchscreen), the cutter will prompt the user to set the tool under the barcode line. The cutter will then scan the line at two points to determine the angle of the printed line. Then the sensor will follow the barcode line till the beginning and then start scanning the barcode.

***The OPOS origin is set to 'Current Position'***

Upon receiving the command to start reading the barcode (from the computer or from the touchscreen), the cutter will immediately start searching for the OPOS barcode line by slowly advancing the media. Once it has found the line, it will then scan the line at two points to determine the angle of the printed line. Then the sensor will follow the barcode line till the beginning and then start scanning the barcode.

***OPOS origin is set to 'Media centre'***

Upon receiving the command to start reading the barcode (from the computer or from the touchscreen), the cutter first sets the OPOS sensor in the middle of the media. Then it will start searching for the OPOS barcode line by slowly moving forward the media. Once it has found the line, it will then scan the line at two points to determine the angle of the printed line. Then the sensor will follow the barcode line till the beginning and then start scanning the barcode.



**NOTE:** The OPOS Barcode workflow is explained in section 3.3.4.

### 3.3.2 Cutting multiple copies of a graphic on the same roll

If the same graphic design has been printed on a roll with equal distance between these graphics, this feature can be used.



**NOTE:** The distance between the multiple copies should be at least 30mm.

Power on the cutter and load the media.

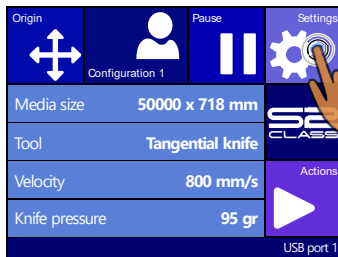

1. Press Settings



2. Press More

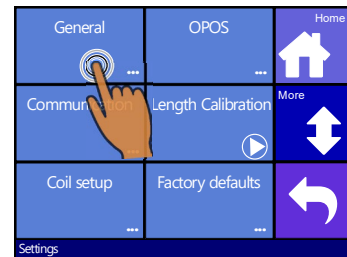

3. Press general

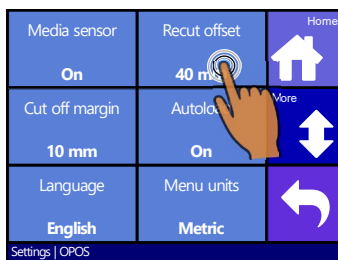

4. Press Recut offset.

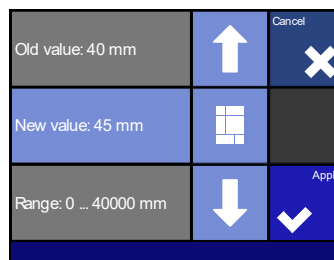

5. Use the arrows to change the value. Then press apply.

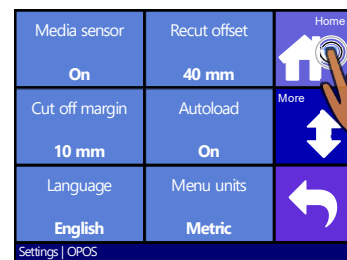

6. Press Home to get online again.

7. Make the first copy as you would make a normal OPOS job.

*The cutter will stop after the first contour has been cut and will come online again.*

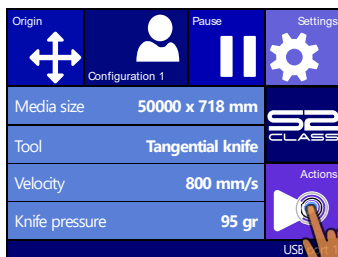

8. Press Actions



9. Press Replot

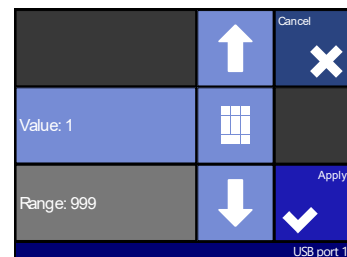

10. Use the arrows to change the value. Press apply.

*OPOS will sense the marks for the second contour and then cut that contour. This process of sensing and cutting will repeat itself automatically until all remaining contours have been cut.*



**NOTE:** If the cut off command is used, the recut distance should be at least 30mm larger than the cut off distance.

### 3.3.3 Cutting the same graphic on multiple media sheets

If the same graphic design needs to be printed on multiple sheets, this feature can be used.



**NOTE:** The sheets should have more or less the same size, and the graphics on them should be oriented and positioned the same way.



**NOTE:** OPOS sheet mode ignores the parameter OPOS origin, so the tool will always have to be set manually for the first job.

First, load the media and check whether the parameters of the OPOS marks are set correctly.

*Cutting the same graphic on multiple media sheets:*

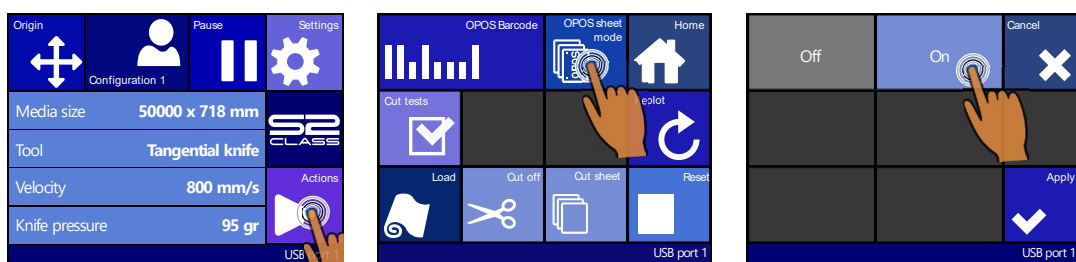

1. Press Settings.
2. Press OPOS sheet mode.
3. Press Apply.
4. Do the job on the first sheet.

*The cutter will stop after the first contour has been cut and will come online again.*

5. Raise the pinch rollers and remove the sheet manually.
6. Insert the next sheet into the cutter. Lower the pinch rollers.



**NOTE:** The second and any following sheet must be loaded in the cutter at the same position and orientation as those from the first sheet. When in OPOS sheet mode, the cutter stores the distance between the edges of the sheet and the first OPOS mark.



**NOTE:** Use easy orientation points to be able to quickly position the sheet. In the figure below, a rim of the base plate and the side of the pinch roller assembly are used to align the sheets.

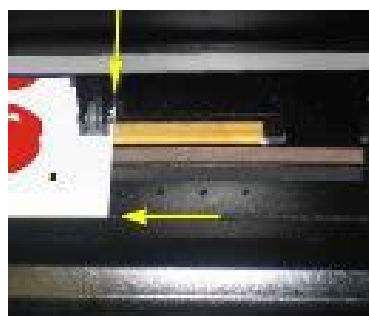

FIG 3-3  
POSITIONING THE MEDIA FOR MULTIPLE SHEETS

### 3.3.4 OPOS Barcode

#### 3.3.4.1 Introduction

The S Class 2 cutters can also read a barcode. Certain RIP's can print a barcode together with the OPOS markers. This barcode can then be used to identify the job and retrieve the needed cut data automatically from the computer.

A program must run on the computer that will act as a barcode server. This program monitors the connection with the cutter. Once a barcode is sent from the cutter, it will search for the corresponding file with the correct cut data on a server (where the RIP has written the cut file) and then send this file to the cutter. Once the file is sent, the barcode server waits again for a new barcode. In this way, a complete roll can be cut without user intervention.

Depending on the program (barcode server), the procedure will have to be started from the control panel of the cutter or from the program (Summa's barcode server contains both options). To start the barcode procedure from the program, refer to the user manual of the program in question. To start the procedure from the control panel, follow the procedure described in section 3.3.4.2.

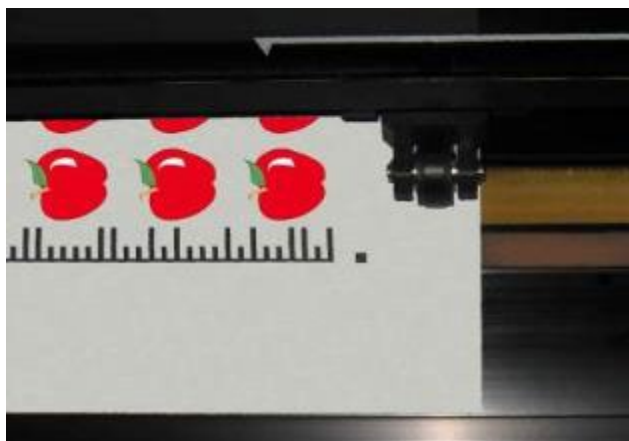
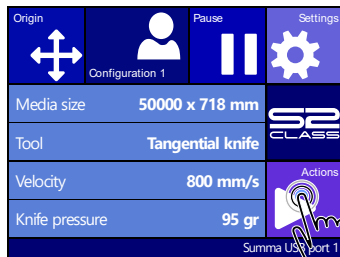

FIG 3-4  
OPOS BARCODE JOB LOADED

**3.3.4.2 Initiating the barcode procedure**

1. Power on the cutter and load media.
2. If the procedure has to be started from the computer ( barcode server program) then click on the start icon in the program (please refer to program manual for more info). Then jump to step 5.



**3. Press Actions.**

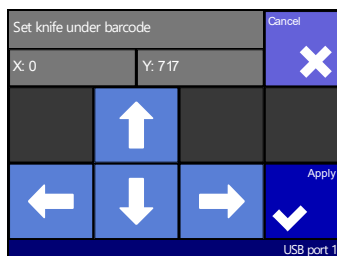

**5. Use the arrows to set the knife under the barcode and press Apply.**

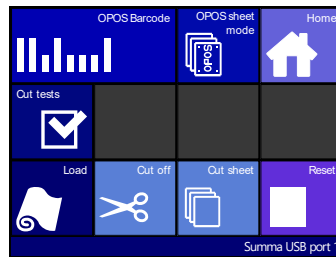

**4. Press OPOS barcode icon.**

*The cutter will prompt the user to put the knife under the barcode.*

*The cutter will read the barcode and send this data to the computer.*

- The cutting software will then automatically send the correct cutting data to the cutter.
- The cutter will start sensing the OPOS markers and cut out the job.
- The OPOS sensor will now search whether another job was printed after the one that is just finished and will continue to contour-cut.

This will be repeated until all contour-cut jobs on the loaded roll are cut out.



### 3.4 Calibrating OPOS

To ensure that OPOS is working accurately, two calibrations are necessary: the OPOS calibration and the media calibration. The OPOS calibration is the calibration of the distance between the knife tip and the sensor. The media calibration “teaches” the cutter the reflection levels of the mark colour and the media colour.



**NOTE:** Although the OPOS sensor has been calibrated in the factory, Summa recommends doing a test to determine how well the factory-set parameters work with the materials you are using. If the accuracy is not what is expected, then perform the OPOS calibration.

#### 3.4.1 OPOS calibration

1. Switch the cutter on and load black vinyl with a white backing.



**NOTE:** Black vinyl with white backing **MUST** be used when calibrating OPOS.

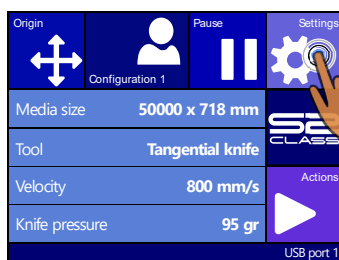

2. Press Settings

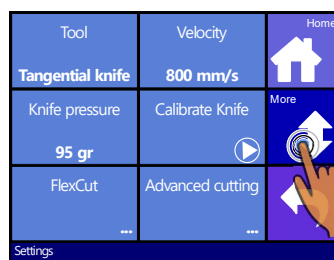

3. Press More

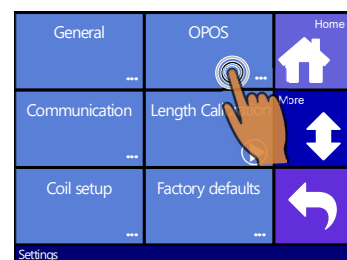

4. Press OPOS.

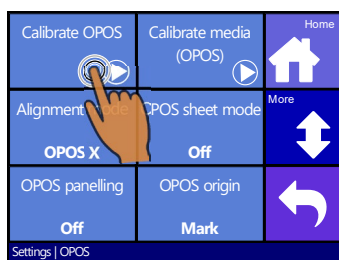

5. Press Calibrate OPOS

*The cutter will cut out a square, measuring approximately 9.5x9.5mm and move the square forward. “Weed out Rectangle” will appear on the display.*

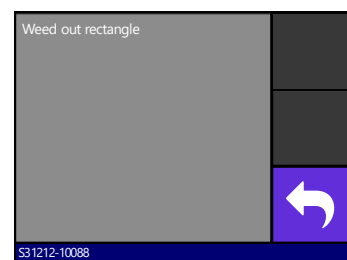

6. Carefully weed the square, making sure the edges stay intact. Press Back.

*OPOS will read the edges of the square and calibrate itself accordingly.*



**NOTE:** In order to keep the accuracy of the OPOS sensor as high as possible, do this calibration each time the knife is been replaced.

### 3.4.2 Media calibration

Media calibration ensures that the sensor can recognize the marks. OPOS is calibrated at the factory to work on a wide range of media. However, certain media -- such as those with a high gloss -- may not work with the default settings. Before working with such materials, perform a media calibration test. This test will alter OPOS's sensitivity so that it will read the marks with greater reliability. Print a square measuring at least 4x4 cm on the used media. Make sure to use the same ink than the one when creating the registration marks.



**NOTE:** If the media calibration is done and results didn't improve, set the media calibration value again to default.

Perform the media calibration:

1. Turn on the cutter and load the vinyl with the printed square.

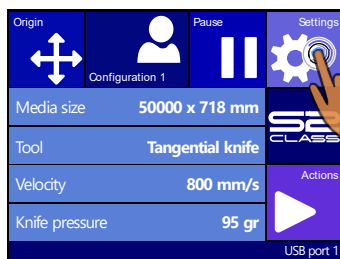

2. Press Settings



3. Press More

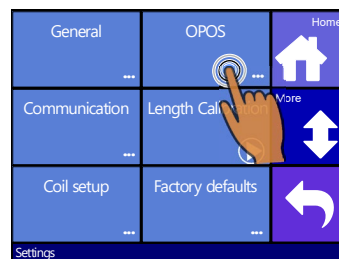

4. Press OPOS.

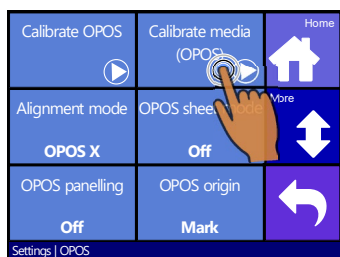

5. Press Calibrate media (OPOS)

The cutter allows the user to choose to either measure the media or to fill in a previously recorded value.

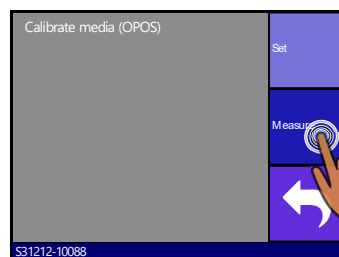

6. Press measure.

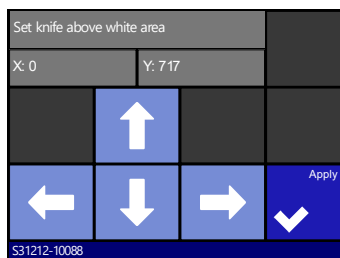

7. Use the arrows to maneuver the knife in the middle of the white area, press apply.

The cutter will make a circular movement while it measures the reflection of the media. It will briefly display the measured values and display the message "put knife on printed area."

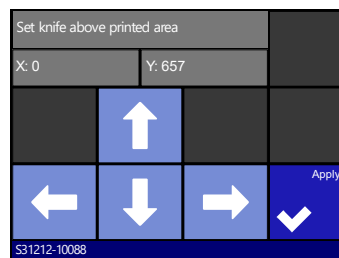

8. Use arrows to maneuver the knife in the middle of the printed area. Press apply.

*The cutter will make a circular movement while it measures the reflection of the mark colour. Then it will show a value that is characteristic of this media colour – mark colour combination. Store this value for future reference.*



**NOTE:** An error message may appear if the sensor is not able to differentiate between black and white. Make sure that the test has been performed correctly.



**NOTE:** If a combination of media color – mark color has already been calibrated and recorded,  this can be used to enter the value directly, without having to re-measure it.

## 3.5 OPOS CAM

### 3.5.1 General

The T4 S Class models use a small USB camera instead of the OPOS sensor for registering the OPOS marks. All normal OPOS procedures, as described above in this manual, can be used, provided that the registering device is a camera. However, there are some small differences. These differences are described in this section.

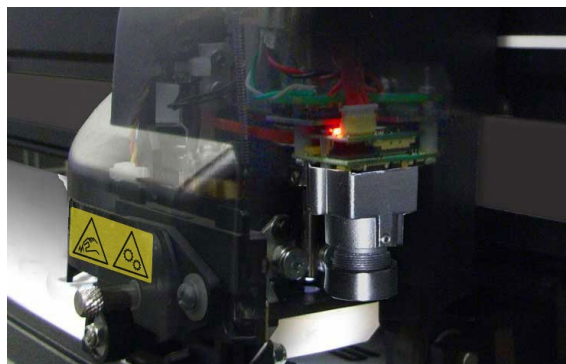

FIG 3-5  
OPOS CAM

The camera option cannot function if it is not connected to the computer. If the cutting software is not equipped with the possibility to process the data from the camera, then use Summa Cutter Control to do this.

Most software simply places the marks and sends the cut data to the cutter. They do not have the ability to process the camera data. Summa Cutter Control will then process the camera data in order to determine the position of the printed marks.

Some software is fully automatic and places the marks, sends data to the cutter and processes the camera data.

Please refer to the user's manual that came with your software or contact your software dealer for details.

The camera images need to be processed by a computer. This means that a cutter with camera option needs a dedicated Windows computer. Only one cutter with camera option can be connected to this computer. This connection also has to be a USB connection. The camera images cannot be transferred to the computer through an Ethernet connection.

The utility to process the camera data is integrated in the program Cutter Control. Therefore, Summa Cutter Control needs to be initiated before doing OPOS jobs with the cutter. If the program Cutter Control detects a cutter where the camera option is connected to the computer, it will start up the camera module, so it is ready when the cutter will send images to the computer that need to be processed.

### 3.5.2 Differences in calibrating OPOS CAM vs OPOS sensor

#### 3.5.2.1 OPOS calibration

The OPOS calibration of a cutter with the OPOS CAM option is very similar to the OPOS calibration of a cutter with an OPOS sensor.

1. Switch the cutter on and load black vinyl with white backing. Make sure Summa Cutter Control is running on the computer that is connected to the cutter.



**NOTE:** Black vinyl with white backing MUST be used when calibrating OPOS.

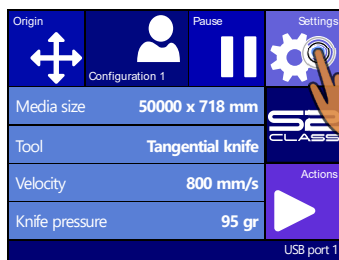

2. Press Settings



3. Press More

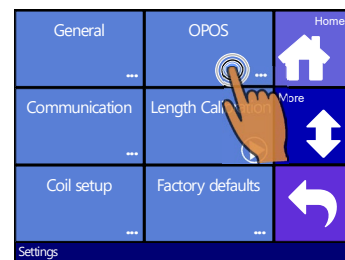

4. Press OPOS.

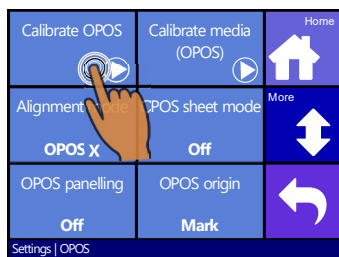

5. Press Calibrate OPOS

*The cutter will cut out two squares, a little one inside a big one. Afterwards it will feed the media forwards. "Weed out Rectangle" will appear on the display.*

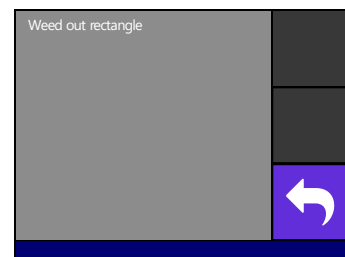

6. Carefully weed the rectangle, making sure the small square stays on its place. Press Back.

*OPOS will register the position of the little square and calibrate itself accordingly.*

#### 3.5.2.2 OPOS media calibration

This option is not available in the menu on the cutter. The camera has to be calibrated with the program Cutter Control. The cutter tools manual describes how to do this.



## 4.1 Introduction

This section is a detailed list of all parameters that can be changed and of tests that can be initiated from the touch screen.

Section 1 and 2 of this manual describe in detail the most commonly used touch screen manipulation.

This section can be used as a reference for locating a certain parameter setting or test. The less frequently used parameters are also explained in this section.

## 4.2 Action Menu

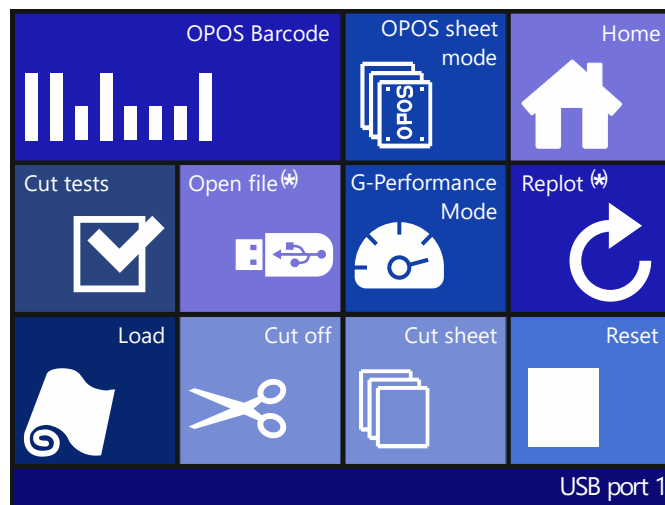

FIG 4-1  
ACTION MENU

(\*) ONLY VISIBLE WHEN AVAILABLE

### 4.2.1 OPOS Barcode

Click this to start the barcode workflow (see section 3.3.4).

### 4.2.2 OPOS sheet mode

This button is a shortcut to activate the OPOS sheet mode (see section 3.3.3).

### 4.2.3 Home

Click Home to leave the action menu.

### 4.2.4 Cut Tests

Click Cut Tests to go to the internal test menu. Currently, there are two internal tests available.

#### The DIN A4 test

The DIN A4 Test performs an electrical and mechanical test of the cutter in order to check the cutting quality. It also provides feedback on knife setting, knife pressure, knife offset, and cutting depth.

This cut is always run as a DIN A4 portrait/A-size image, regardless of the actual size of the loaded media. If the loaded media is smaller than a DIN A4/A-size, a part of the outer box will be clipped (not cut).

#### The confidence test

The confidence test performs a quick electrical and mechanical test of the cutter to make sure that the cutter is fully operational. A media sheet of at least A3/B-size should be used for this plot. This test is always cut at the left side of the loaded media.

### 4.2.5 Open file

Use this option to cut directly from the USB flash drive or to upgrade the cutter. Click on the icon to see the list of the files that are present on the USB stick.

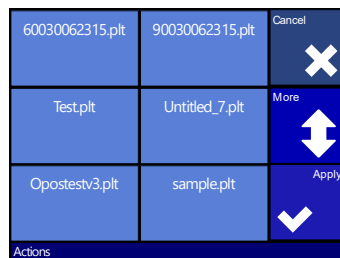

Select the file to cut, press apply

*The cutter now cuts out the file. If the file has a new version of firmware, then the firmware is upgraded. However, it is recommended to upgrade with the program Summa Cutter Control, if possible.*



**NOTE:** The cutter only accepts files with cutting data. Those are HPGL or DMPL files made by software that is used to drive the cutter directly. As extension they can have .plt, dmp, .hpg, hgl or .hgp.



### 4.2.6 G-Performance

Click this to enter the activation code for the G-performance mode. The activation code can be downloaded from the internet. Go to [www.summa.eu/gperformance](http://www.summa.eu/gperformance) to register. A code (or unlock file) will be given.

#### 1. Switch on the cutter.

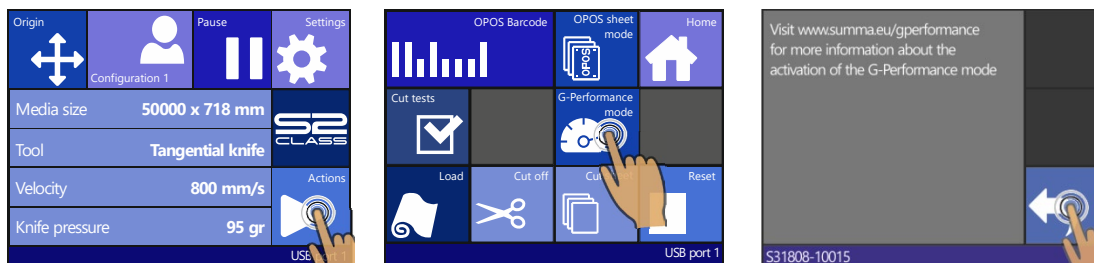

#### 2. Press Actions

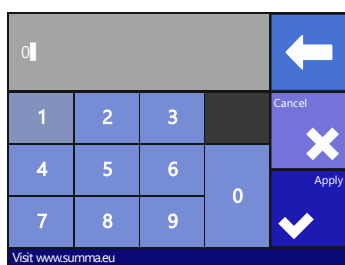

#### 3. Press G-Performance mode



#### 4. Press enter

5. Press the arrow button and enter the activation code. Then press Apply
6. Press enter.

### 4.2.7 Replot

Each job is stored in the cutter's memory until a new job is sent. Pressing replot allows the job to be replotted. After this button is pressed, the user can choose the number of replots. The replot button does not work if there is no job in the memory or if the previous job was larger than the cutter's memory.

### 4.2.8 Load

The load menu is explained in detail in section 1.6.4.

### 4.2.9 Cut Off

This functionality cuts of the currently loaded material.

### 4.3 Configuration Menu

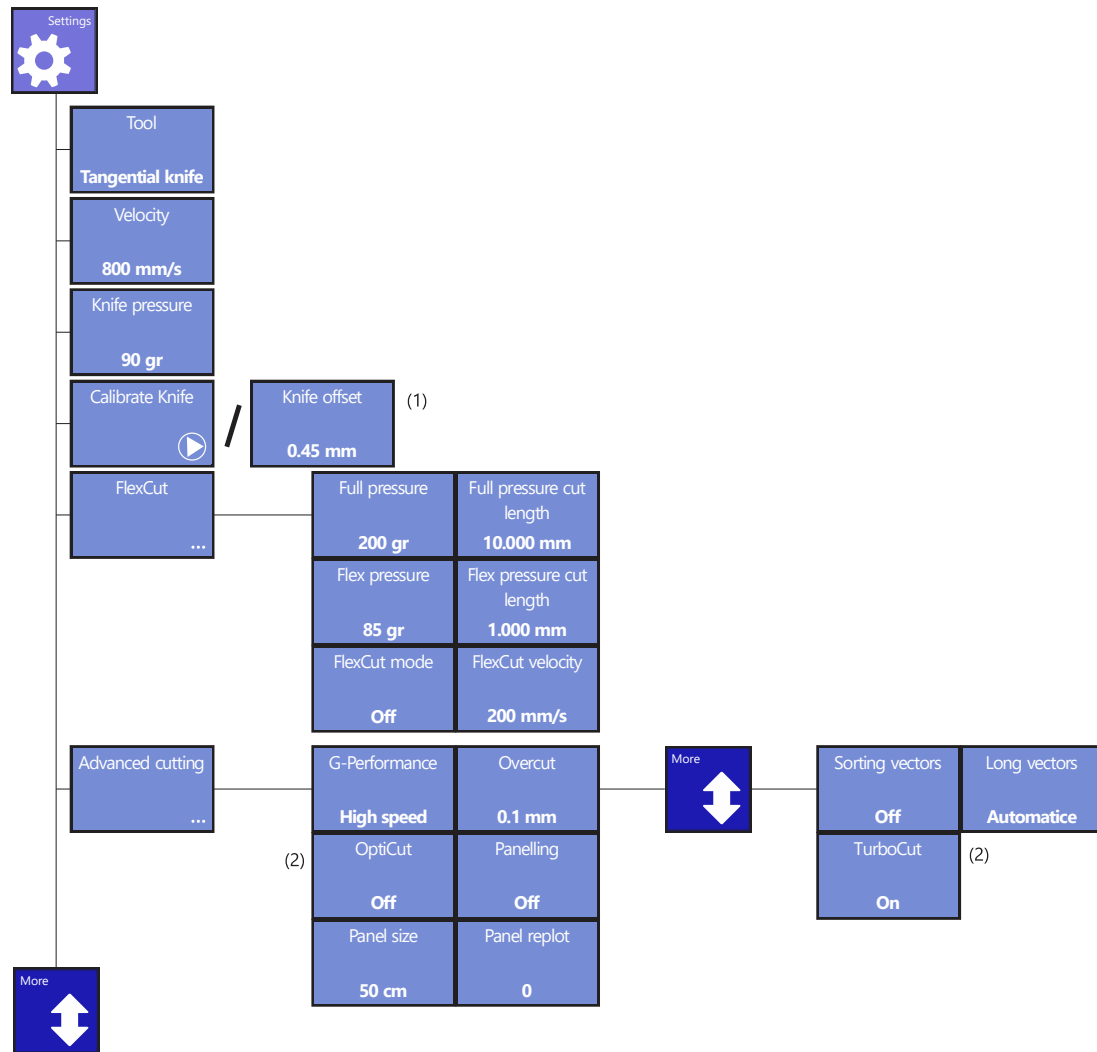

FIG 4-2  
CONFIGURATION MENU

- (1) Depends on the tool setting.
- (2) Not visible if the tool is not a drag knife.

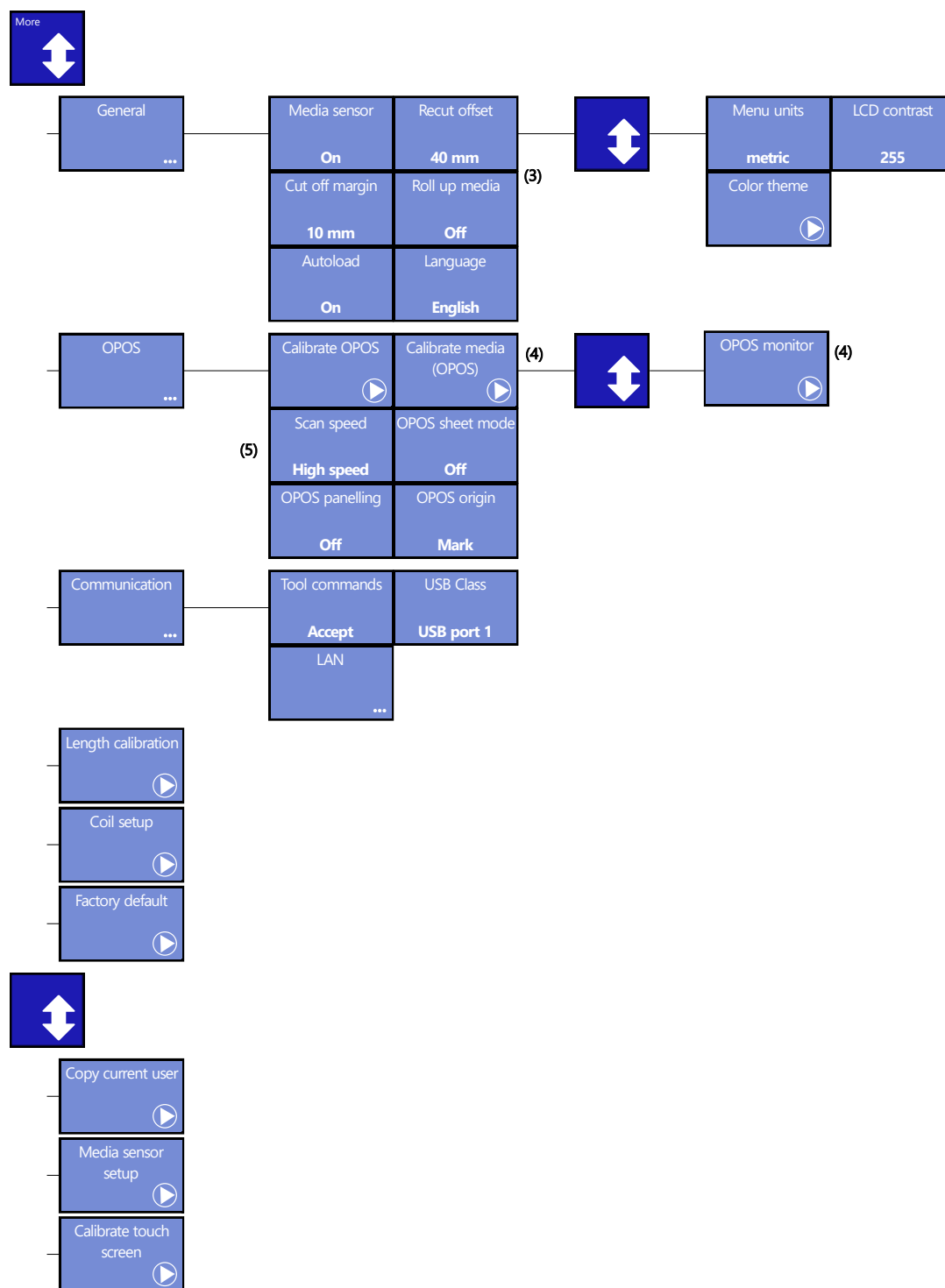

FIG 4-3  
CONFIGURATION MENU



- (3) Only visible if the roll up option is installed.
- (4) Not visible on OPOS-CAM machines.
- (5) Not visible when G-performance is not enabled and on OPOS-CAM machines.

### 4.3.1 Settings

This menu bundles all the settings of the S CLASS 2 cutters. All settings in this section, apart from the OPOS parameters, are user-dependent (information is contained within each of the eight individual user settings, see section 2.1.5).

#### 4.3.1.1 Tool

The **Tool** submenu is used to change the default tool at power-up (same as in section 2.2.1, but it can be changed when no media is loaded).

Press the tool button, press the tool for another default tool. Press  to confirm or  to cancel. After changing the tool, the cutter will ask the user to confirm that there was a tool

change just before it comes online. If media is loaded (press ).





**NOTE:** Do not forget to check and/or recalibrate the tool settings when a tool was changed (see section 1.7). OPOS calibration needs to be executed again, as well. (see section 3.4.1).

#### 4.3.1.2 Velocity

The **Velocity** submenu is used to change the default velocity (the same as in section 2.3 but it can be changed when no media is loaded).

Press the Velocity button, then press the desired velocity to change the velocity. Use the up/down arrow if the desired velocity is not visible on the screen.

Press  to confirm or  to cancel.



#### 4.3.1.3 Knife pressure



**NOTE:** The term 'knife' can have a different meaning when the tools have been set.

The **Knife pressure** submenu is used to change the default knife pressure (the same as in section 2.2.2 but it can be changed when no media is loaded. However, it can't be tested).

Press the knife pressure button, then change the knife pressure to the desired knife pressure.

Press  to confirm or  to cancel.

#### 4.3.1.4 Calibrate Knife



**NOTE:** Another menu item is available if the tool is a drag knife (see section 4.3.1.5) or a pouncer (see section 4.3.1.6).

The **Calibrate knife** submenu is explained in section 2.2.4.

#### 4.3.1.5 Knife offset

The **Knife offset** submenu is explained in section 2.2.3.

#### 4.3.1.6 Pouncing gap

The **Pouncing gap** submenu is used to change the pouncing gap (distance between the holes that are punched in the material by the pouncing tool).

Press the Pouncing gap button, then change the pouncing gap to the desired distance. Press



to confirm or



to cancel.



**NOTE:** The pouncing tool is not mounted in the machine at the same place than the other tools. The pouncing tool should be mounted this way the center of the pin is located above the black soft pouncing strip.

#### 4.3.1.7 FlexCut

FlexCut should be controlled by the software. When the FlexCut mode is on, the cutter will alternately cut a certain length with full pressure and a certain length with reduced pressure. The advantage of the FlexCut feature is that it cuts completely through the material. Moreover, it also allows the material to stay together by means of the small media bridges. Several modes exist, depending on the software that is used.

There are 5 typical FlexCut parameters:



1. *Full pressure:* This parameter determines full pressure, used during FlexCut mode.
2. *Full pressure cut length:* This parameter determines the length that is cut with full pressure; usually the length that will be cut all the way through.
3. *Flex pressure cut length:* This parameter determines the length that will be cut with reduced pressure or without pressure. This is usually a much smaller value than the full pressure cut length – this is the length of the media bridges.
4. *FlexCut pressure:* This parameter determines the pressure of the Flex pressure cut length. This is usually a reduced pressure, so that the knife only scratches the media or only cuts it halfway through.
5. *FlexCut Velocity:* FlexCut uses higher knife pressures. Higher knife pressures need lower cutting speed. With this parameter the velocity of FlexCut can be set independently from the normal cutting velocity. For more info see section 2.5.1.

## 4.3.1.8 Advanced cutting

**G-Performance:**

G-Performance is designed to enhance the speed / performance of digital finishing operations on the S2 roll cutters up to 40%. Activating this option to 'high speed' enables faster cutting speeds on wider substrates, provided the used material can handle the higher acceleration and speeds. The option is only visible if the mode is activated (see section 4.2.6).

Press the G-Performance button, then set it to High speed or High quality.

Press  to confirm or  to cancel.

**Overcut:**



Use the **Overcut** submenu to generate an overcut in order to facilitate weeding the cut. Each time the knife goes up or down, the cutter cuts a bit further than it should. Figure 4.3 below shows what overcut does with a tangential knife. A sample, cut out with a drag knife, shows fewer overcuts because there are fewer up/downs (usually only one per curve/letter).

The overcut setting can be disabled (=0) or set to any value between 0(=off) and 10. One unit is about 0.1 mm or 0.004 ".



FIG 4-4  
OVERCUT



Press the Overcut button, then change the overcut to the desired value.

Press  to confirm or  to cancel.

**OptiCut:**

OptiCut increases the cutting quality in case the knife is worn out or not calibrated correctly. OptiCut is default set to OFF.



Press the OptiCut button, then set it off or on.

Press  to confirm or  to cancel.

**Paneling:**



Use the **Paneling** submenu to enable or disable the internal paneling function of the cutter. Paneling is used for several different applications. Most common are FlexCut and long jobs with or without the roll up option.

Press the Paneling button, then set it off or on.

Press  to confirm or  to cancel.

**Panel size:**



Use the **Panel size** submenu to set the size of the panel.  
Press the Panel size button, then set it to the desired length.

Press  to confirm or  to cancel.

**Panel replot:**

This parameter determines if the design has to be cut more than once on top of itself and panel per panel. Panel replot is used for thick media and media that is difficult to cut. The value of this parameter is disregarded if paneling is deactivated. If this parameter is set at 0, then the cutter will cut each panel only once. If it is set at 1, it will cut each panel twice. Use the **Panel replot** submenu to set the number of times it needs to be recut.

Press the Panel replot button, then set it to the desired value.



Press  to confirm or  to cancel.

**Sorting Vectors:**

There are three options in this menu.

1. *Off*: When vector sorting is set off, the cutter will not optimize vectors. This is used when the intelligence of the cutter driver is preferred.
2. *Directional*: If set to directional, the vectors are optimized for the cutting direction (media movement). This is used when the cutting pressure needs to be set relatively high (for example when cutting through).
3. *Starting point*: This option optimizes the starting point for closed curves. This is used when the user notices the curves do not close as they should.



Press the Sorting vector button, then set it to the desired value.

Press  to confirm or  to cancel.

**Long Vectors:**



Some vinyls have the tendency to buckle when large designs (long vectors) are cut out. To avoid this, the speed needs to be reduced. This option does this automatically, so the speed and acceleration of small vectors are not affected when the speed is reduced.

Press the Long vectors button, then set it to Automatic or Constant velocity.

Press  to confirm or  to cancel.

**TurboCut:**

**TurboCut** increases throughput without raising the overall speed of the plotter by speeding up the drag movement. The cutting time reduction is significant, especially when cutting small, detailed designs. However, some thicker materials might not be cut properly when this feature is activated.

Press the Turbucut button to set it On or Off. Press  to confirm or  to cancel.

## 4.3.1.9 General

**Media sensor:**



The **Media sensors** detect whether media is loaded and also detect the end of the media. The sensors prevent damage to the cutting strip and knife tip. The sensors can be activated or deactivated with this menu.

When the sensors are activated, the cutter searches for the front end of the media during the loading procedure. If it does not find it after returning the media for 1 m (+/- 3 feet), it stops returning the media and sets the origin in the X-axis.

The cutter will also stop during the loading procedure or while it is cutting if the rear sensor detects the end of the media.

The cutter does not search for the front end of the media and assumes that the loaded media is endless if the sensors are not activated.

Press the media sensor button, then select to activate (ON) or deactivate (OFF) both or only the front sensor (FRONT OFF).

Press  to confirm or  to cancel. The default setting for the media sensors is ON.

**Recut offset:**

The **Recut offset** submenu is used to set or modify the distances between the jobs when making multiple recuts.

Press the Recut offset button, then set it to the desired value.

Press  to confirm or  to cancel. The default value is 40mm.

**Cut off margin:**

The **Cut off margin** submenu is used to set or modify the distance the cutter will feed before it will cut off the job when action 'cut off' is used from the software.

Press the Cut off margin and set it to the desired value.

Press  to confirm or  to cancel. The default value is 10mm.





**NOTE:** The recut offset should be larger than the cut-off margin if both parameters are used in the same job. For OPOS jobs, using the cut-off command, it is required that the recut offset is at least 30mm bigger than the cut-off margin.

**Roll-up media:**

The roll-up media submenu is used to choose when the cutter will start the automatic roll-up. There are 3 possible settings. Off, after job and after AUTO-panel.

Off disables the roll-up system. After job rolls up the media after the job, regardless the number of panels the job contains. After AUTO panel rolls up the media each time a panel is cut. The size of the panel can be set in the Panels menu or is 100 cm when paneling is set to off.

Press the Roll-up media button and set it to the desired value.

Press  to confirm or  to cancel. The default value is after AUTO-panel.





**Autoload:**

The Autoload option enables the user to change the unroll-procedure of the vinyl. When autoload is on, the cutter will automatically unroll the vinyl, when needed. When the autoload option is set off, the operator should manually unroll enough media before starting to cut. When autoload is set to ask, then the cutter will pause after the pinch rollers are put down. This gives the user the time to lower the pinch roller pressure, if necessary.

The default setting is ON. Tracking is not guaranteed when autoload is set to OFF.

Press the Autoload button, then choose to activate or deactivate the autoload feature.



Press  to confirm or  to cancel. Autoload is activated default.



**NOTE:** Tracking is not guaranteed when autoload is set to OFF.



**Language:**

This submenu is used to set or modify the dialogue language on the touch screen. When the machine is new, it asks the user to choose a language. If this setting was set to the wrong language, it can be changed with this option.

The information on the touch screen can be displayed in English, French, German, Spanish, Italian, Polish, Dutch or Lithhaunian.

Press the Language button, and then set it to the desired language.



Press  to confirm or  to cancel. The default language is chosen when the cutter is switched on for the first time.

**Menu Units:**

The setting of these options determines whether the speed and size values are displayed in the metric measure system or ENG/US measure system.

Press the Menu units button, then set it to the desired measure system.



Press  to confirm or  to cancel. panel units are chosen when the cutter is switched on for the first time.

**LCD contrast:**

The **LCD contrast** submenu is used to adjust the contrast (or intensity) of the touch screen. The firmware automatically rejects values that would make the touch screen too dark to be able to use it.

Press the LCD contrast button and set it to the desired value.



Press  to confirm or  to cancel.

## 4.3.1.10 OPOS

The OPOS settings are explained in detail in section 3, except for scan speed and Monitor.

**Scan Speed:**

This parameter is a part of the G-Performance option. It is also only visible if the G-Performance mode is activated. Setting this option to high speed enables faster reading of the marks on wider substrates, provided the used material can handle the higher acceleration and speeds.

Press the Scan speed button and set it to High speed or High quality.



Press  to confirm or



 to cancel.

**Monitor:**

This option shows the read-out of the reflection of the OPOS sensor. The values can be used to report a problem to a certified service technician.



#### 4.3.1.11 Communication

The communication settings menu groups all the parameters that determine the method of communicating with the computer.

##### Tool command:

The TOOL COMMAND option is used to determine whether the DM/PL and HP-GL tool commands (pen select pressure and velocity) are ignored or accepted.

Press the Tool command button and activate or disable.

Press  to confirm or  to cancel.



##### USB class:

The option USB class can be set to Summa USB port 1, Summa USB port 2, Summa USB port 3, Summa USB port 4 or Printer Uni.

The Printer Uni is for using the windows printer spooler.

Because of the different USB id's, the computer can make a distinction between several cutters attached to it (maximum 4).

Press the USB Class button and set to the desired USB Class.

Press  to confirm or  to cancel. The default mode is Summa USB port 1.



**NOTE:** The minimum USB driver version required for attaching more than 1 cutter to the same computer is 6.2. The change in USB class becomes active only after rebooting the cutter.



**NOTE:** The USB id in the cutting software needs to be the same as the chosen USB id in the cutter. Each time a new USB is selected on the cutter and connected for the first time to the computer, the wizard for installing a driver will be started by Windows.

##### LAN:

The LAN menu is explained in section 1.5.2.

#### 4.3.1.12 Length calibration

The option Length Calibration allows the length of the cut lines to be adjusted within the specifications.



For instance, if a cut line needs to measure exactly 100mm, the cutter can be adjusted to avoid any discrepancy.

The Length Calibration is explained in section 0.

#### 4.3.1.13 Coil setup

This test is used to calibrate the knife and pen pressure and to set the knife and pen “landing.” The cut quality is seriously affected by incorrect landing settings. Before changing these values, write them down, as there is no default setting for these parameters.



After adjustment, the value is saved in the system's non-volatile RAM.

Press the button of the parameter that needs to be changed and use   to change the value of the highlighted parameter.

Press  to leave the menu.

#### *Setting the landing*

The landing determines, among other things, the force at which the tool hits the media. When calibrating the landing, the tool holder with the knife must be inserted in the head. Make sure that the knife does not protrude.

Use  to lower the landing value until the tool is in the “up” position. Then use  to raise the value of the parameter. With each change, always check if the tool is completely down. Once the tool is completely down, raise the value back up three units. This will become the proper setting.

#### 4.3.1.14 Factory defaults





This option defaults all user parameters to factory default.

#### 4.3.1.15 Copy current user

Press the button to copy the user parameters from the current user to all the other users. It is recommended to do this only when the current user is user 1.

## 4.3.1.16 Media sensor setup

The media sensor setup option is a useful routine to check whether the front and rear media sensors are functioning properly and whether the switching levels of these sensors are set correctly.



1. Press  or  to select the sensor that will be tested.
2. Put a piece of media half on the chosen sensor and under the two outer pinch rollers. Press . There are five levels of sensitivity to choose from.
3. Use  or  to change the sensitivity level.

*After choosing a sensitivity level, there will be a rectangle next to the sensitivity. When the sensor is covered the rectangle will be (completely) filled with black squares. When the sensor is uncovered, (almost) no black squares will be visible in the rectangle.*



FIG 4-5  
SENSOR SETUP

*The blue stripe in the rectangle is the trigger level at which the cutter decides whether the machine contains media or not.*

4. Use  or  to change the trigger level, if necessary.

Ideally, there would be 0 to 2 black squares when the sensor is uncovered, the rectangle is completely filled when it is covered, and the trigger level is set in the middle.

## 4.3.1.17 Calibrate touchscreen

This option makes it possible to calibrate the touchscreen. Perform this calibration if the illustration of the button on the touchscreen does not match the area that needs to be pressed to activate the button.

Press the button to start the calibration and follow the guidelines on the screen.



### 5.1 Introduction

The S CLASS 2 cutter range has a number of sliding surfaces made of smooth metals and plastics. They are virtually friction-free and require no lubrication. They will, however, collect dust and lint that may affect the cutter's performance. Keep the cutter as clean as possible by using a dust cover. When necessary, clean the unit with a soft cloth dampened with isopropyl alcohol or mild detergent. Do not use abrasives.

#### 5.1.1 Cleaning the drive system

Over time, the sleeves of the drive drum may become clogged with accumulated residue from the media liner. This may cause the media to slip between the pinch rollers and the drive sleeves, thus decreasing traction.

*Cleaning the drive system:*

1. Unplug the power cord.
2. Apply a mild solvent (normally used to remove old glue residue) on the yellow sleeves and wait for it to dissolve the accumulated residue.
3. Clean with a brush (a toothbrush is recommended)
4. Repeat the procedure for all dirty drive sleeves.

#### 5.1.2 Cleaning the media sensors

Over time, the media sensors may become dirty with accumulated residue from the media. This may cause the cutter to malfunction.

Clean the media sensors by wiping them out with cotton swabs.

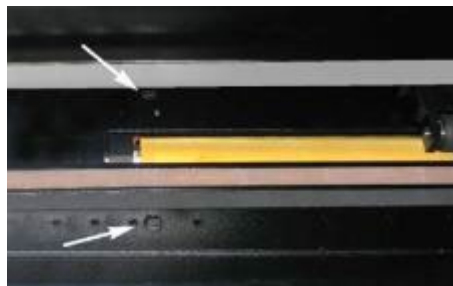

FIG 5-1  
MEDIA SENSORS S CLASS 2 CUTTERS

### 5.1.3 Cleaning the Y-Guide Rail

There are 4 areas on the Y-guide rail on which the tool carriage slides from left to right. Two areas (1) are visible on the front side of the guide rail. The other 2 surfaces (2) are situated on the back of the guide rail, directly behind the areas that are visible at the front. Figure 5-4 below shows these areas. Although the shape of the Y-guide rail may differ from model to model, the areas are located in the same place at the top and bottom of the guiding.

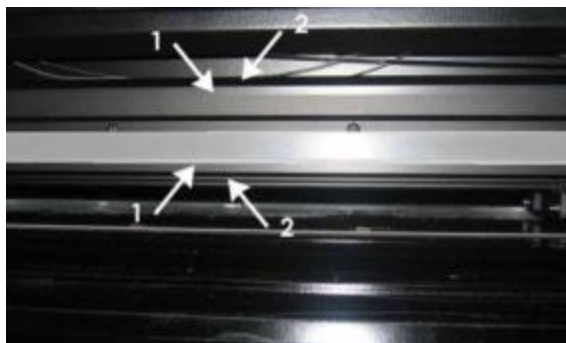

FIG 5-2  
SLIDING SURFACES ON Y-GUIDE RAIL

Over time, there may be some accumulated residue on these sliding surfaces and on the rollers of the tool carriage.

*Cleaning the sliding surfaces of the Y-Guide rail:*

1. Switch off the machine.
2. Take a soft cloth dampened with isopropyl alcohol or mild detergent.
3. Clean the surfaces. When the tool carriage is in the way, push it gently to the left or right.

### 5.1.4 Cleaning the nose piece (tangential machine only)

The nosepiece may accumulate residue from the vinyl that will result in poor cut quality. The typical indication of a dirty nosepiece is an interruption of the cut line every 12mm (0.5”).

*Cleaning the nose piece:*

1. Gently remove the knife by turning the knife holder counterclockwise.
2. Observe the orientation of the nosepiece and then push it out of its holder.
3. Remove any remaining vinyl residue using a brush or a pair of tweezers.
4. Replace the nosepiece.
5. Install the knife as described in section 1.7.2.1.



### 5.1.5 Cleaning the OPOS system

The optical system will collect dust. Therefore, the small hole in the sensor should be cleaned regularly with a cotton-tipped swab.

*Cleaning the OPOS system:*

1. Pull the knife holder upwards.
2. Locate the sticker over the hole in the OPOS sensor holder at the left side of the tool carriage.
3. Remove the sticker.
4. Clean by wiping it out with cotton swabs.
5. Cover the hole again with a similar sticker.
6. Push the head all the way to the right to ensure that OPOS is raised again.

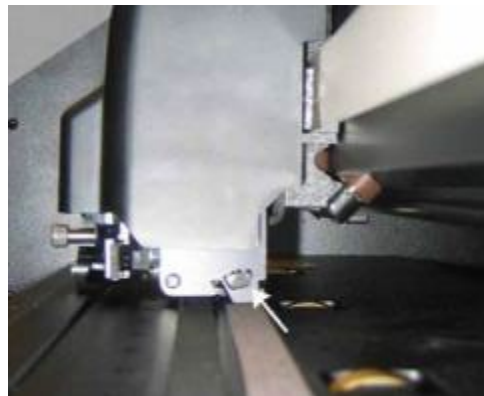
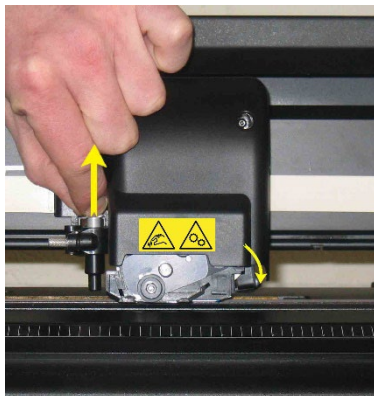

FIG 5-3  
CLEANING THE OPOS SENSOR

## 5.1.6 Changing the fuse



**WARNING:** Before changing the fuse, make sure that the cutter is completely disconnected from its power source.



**WARNING:** For continued protection against risk of fire, replace only with the same type and rating of fuse: T2AH 250V SCHURTER SPT OR EQUIVALENT.

1. To remove the fuse (3), lightly pry the fuse holder release clip (2) in the direction opposite the power switch. The fuse holder will pop free.

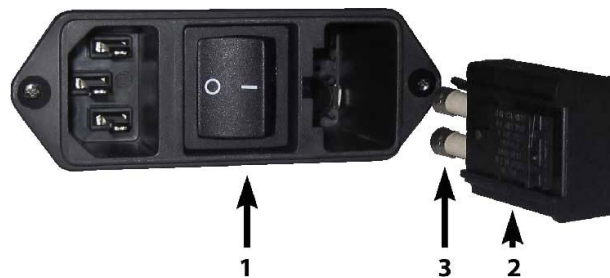

FIG 5-4  
POWER ENTRY MODULE

2. Remove the fuse holder.
3. Pull the fuse from the holder.
4. Put the new fuse in the holder and clip the holder back into place.



---

## 6 Specs and General Information

### 6.1 Introduction

The S CLASS 2 range of cutters has been designed to produce computer-generated graphic designs on cut sheets or roll vinyl media. Using the integrated optical positioning system (OPOS) allows contour cutting of printed sheets of material. By replacing the knife with a pen, these cutters can also be used to produce inexpensive previews of new graphic designs on paper.

The following cutter models are currently available:

- The S2 75, which can handle media widths from 60 mm up to 840 mm (2.4" to 33").
- The S2 120, which can handle media widths from 115 mm up to 1300 mm (4.5" to 51").
- The S2 140, which can handle media widths from 170 mm up to 1450 mm (6.7" to 57").
- The S2 160, which can handle media widths from 170 mm up to 1680 mm (6.7" to 66").

#### 6.1.1 Product features

Following are the main features of the S CLASS 2 cutters.

- Variable media widths.
- User-selectable DM/PL, HP-GL, and HP-GL/2 software languages.
- Interchangeable pouncing tool with its own pouncing strip.
- Integrated OPOS positioning and alignment system.
- Interchangeable pen for producing preview plots of sign designs on paper.
- Adjustable knife pressure and offset settings controlled by microprocessor.
- Communication with host computer via standard USB or Ethernet 10/100.
- 3.5 inch color touchscreen panel for convenient operator control.
- Metric or English units.
- User-addressable curve resolution: 0.1 mm, 0.025 mm, 0.001" or 0.005".
- Menu mode for selection of the cutter's power-up operating configuration.

- Wide variety of cutting speeds (in metric or English units).
- Up to eight separate user configurations stored in a non-volatile memory.
- Media support system for automatic loading of media with optional “shuffling” to guarantee tracking of longer signs.
- Automatic media pull from roll.
- Media sensing.
- Concatenation and curve smoothing to obtain better cut quality.
- Multiple recut feature.
- USB A receptacle to connect USB flash drives.
- Tool calibration tests.
- Overcut for easy weeding, OptiCut for prolonged drag knife life.
- Stand and basket.
- Automatic cut sheet feature and sheet cut feature.

## 6.2 Specifications

### 6.2.1 Cutter

	S2 75		S2 120		S2 140		S2 160	
	mm	inch	mm	inch	mm	inch	mm	inch
<b>Height</b>	1110	43.7	1110	43.7	1110	43.7	1110	43.7
<b>Width</b>	1410	55.5	1870	73.6	2021	79.6	2250	88.6
<b>Depth folded basket</b>	680	26.8	680	26.8	680	26.8	680	26.8
<b>Depth open basket</b>	1080	42.5	1080	42.5	1080	42.5	1080	42.5
	Kg	pounds	Kg	pounds	Kg	pounds	Kg	pounds
<b>Weight</b>	49.5	109	61.5	135.6	65.5	144.5	71	156.5

FIG 6-1  
S CLASS 2 CUTTER SPECIFICATIONS

### 6.2.2 Media

	S2 75		S2 120		S2 140		S2 160	
	mm	inch	mm	inch	mm	inch	mm	inch
<b>Width</b>	60 - 840	2.4 - 33	115 - 1300	4.5 - 51	170 - 1450	6.7 - 57	170 - 1680	6.7 - 66
<b>Maximum cutting width<sup>(*)</sup></b>	742	29.2	1200	47.2	1350	53.1	1580	62.2
<b>Min margin left/right<sup>(**)</sup></b>	25	1	25	1	25	1	25	1
<b>Front margin</b>	45	45	45	45	45	45	45	45
<b>Rear margin</b>								
Sensor on	45	1.75	45	1.75	45	1.75	45	1.75
Sensor off	33	1.3	33	1.3	33	1.3	33	1.3
<b>Tracking Performance<sup>(***)</sup></b>	± 0.1mm up to 12 m (vinyl < 760mm) ± 0.004" up to 40 feet (vinyl < 30")				± 0.1mm up to 4 m (vinyl >760mm) ± 0.004" up to 13 feet (vinyl >30")			
<b>Media Thickness</b>	0.05mm to 0.25mm 0.002" to 0.01"		Up to 0.8mm (0.03" ) with sandblast drag knife Up to 1.2mm (0.047" ) with sandblast tangential knife					

(\*) Maximum cutting width in normal mode, 'oversize mode' allows a wider cutting area

(\*\*) For positioning of the pinch rollers (see section 1.5.1).

(\*\*\*) Media lengths greater than the specified length can be handled, but compliance with specifications is not guaranteed (depends on media type, media size and other parameters).

FIG 6-2  
S CLASS 2 MEDIA SPECIFICATIONS

### 6.2.3 Knife, pen and pouncing tool

The S CLASS 2 cutter comes equipped with all the tools necessary to start working immediately.

Some tools are pre-installed, while others are packaged in separate boxes.

Below is a table that specifies which tools are delivered with the cutter. Please make sure that all tools are included with the cutter.

	Medium	Drag	Tangential
<b>Standard drag knife</b>	Standard vinyl	<b>2</b>	<b>1</b>
<b>Sandblast drag knife</b> (requires sandblast knife holder)	Sandblast and thicker soft materials max 0.8mm	<b>x</b>	<b>x</b>
<b>Standard tangential knife</b>	Standard vinyl	<b>x</b>	<b>2</b>
<b>Sandblast tangential knife</b> (requires special sandblast nose piece)	Sandblast and thicker soft materials max 1.2 mm	<b>x</b>	<b>1</b>
<b>Ball point pen</b> (requires ballpoint penholder)	Paper	<b>x</b>	<b>1</b>
<b>Pouncing pin</b>	Paper	<b>x</b>	<b>1</b>
<b>Razor blade for cut sheet</b>	Standard vinyl up to 0.25mm (0.03") thick	<b>2</b>	<b>2</b>

FIG 6-3  
S CLASS 2 TOOLS

To order replacement knives, pens and/or pouncing tools, contact your local Summa dealer, quoting the part numbers listed in table 6-8 to 6-10.



**NOTE:** The S CLASS 2 cutters will only perform according to specifications if a genuine Summa knife, pen or pouncing tool is installed. Do not replace the standard knife, pen or pouncing tool with products from other manufacturers.

## 6.2.4 Interface

<b>Communication</b>		USB and Ethernet 10/100 base connection
<b>USB</b>	I/O Port connector Mating connector Version	USB series "B" receptacle (female plug) USB series "B" plug (male plug) 1.1
<b>Ethernet</b>	I/O Port connector	RJ45 female connector
<b>USB Flash Drives</b>	USB A receptacle	FAT 32, max 8GB and max 100 files. Only cut files (DMPL and HPGL files) or firmware files ( files with extension summa1)

FIG 6-4  
S CLASS 2 INTERFACE SPECIFICATIONS

## 6.2.5 Firmware

<b>Language (*)</b>	DM/PL, HP-GL (758x emulation), HP-GL/2
<b>Supported character sets</b>	Standard ASCII
<b>Supported fonts</b>	Sans serif (single stroke & medium)
<b>ROM-based plots</b>	Confidence plot, DIN plot

(\*) The cutter detects the emulation language automatically at the start of the sent cut data.

FIG 6-5  
S CLASS 2 FIRMWARE

## 6.2.6 Performance

Cutting specifications on 0.05 mm (0.002") wax-backed vinyl; total media thickness not greater than 0.25 mm (0.010").

<b>Axial speed</b>	50 to 1000 mm/s	2 to 40 ips
<b>Default speed</b>	800 mm/s	32 ips
<b>Acceleration</b>	Up to 5.5 G	
<b>Addressable resolution</b>	0.025 mm, 0.1 mm	0.001", 0.005"
<b>Default resolution</b>	0.025 mm	0.001"
<b>Mechanical resolution</b>	6.3 µm	0.25 mil
<b>Accuracy</b>	0.2% of move or 0.25 mm, whichever is greater (*)	0.2% of move or 0.010", whichever is greater (*)
<b>Knife pressure for drag head</b>	0 to 400 gr.	
<b>Pen pressure for drag head</b>	0 to 400 gr.	
<b>Pouncing pressure for drag head</b>	0 to 250 gr.	
<b>Knife pressure in tangential head</b>	0 to 600 gr.	
<b>Pen pressure in tangential head</b>	0 to 600 gr.	
<b>Pouncing pressure in tangential head</b>	0 to 250 gr.	

\*Excludes differences due to media expansion, stretching, etc.

FIG 6-6  
S CLASS 2 PERFORMANCES



## 6.2.7 Environmental

(Cutter without media)

Operating Temperature	15 to 35° C	59 to 95° F
Storage temperature	-30 to 70° C	-22 to 158° F
Relative humidity	35 - 75 %, non-condensing	

FIG 6-7

### S CLASS 2 ENVIRONMENTAL SPECIFICATIONS



**IMPORTANT HINT:** The use of dimensionally stable media is an essential prerequisite to obtain high cut quality. Additionally, media expansion or contraction may occur as a result of temperature variations. To improve the dimensional stability of media, let it stabilize to the current environmental conditions before use, for a minimum period of 24 hours.

## 6.2.8 Electrical

Operating voltage: 100-240V 50/60 Hz

Fuse T2AH 250V Schurter SPT or equivalent.



**WARNING:** For continued protection against risk of fire, replace only with the same type and rating of fuse.

**6.3 Cutter accessories and consumables**

The following charts contain descriptions and part numbers for the S CLASS 2 accessories.

D Series

Part description	Part number	Picture
Standard Drag Knife Holder / Dia 1.5 mm	9TL89-67033	
Standard Drag Knife 36° / Dia 1.5 mm (5 pcs)	9TL89-67041	
Drag Knife 60° / Dia 1.5 mm	391-231	
Drag Knife Holder for Sandblast Knife / Dia 2 mm (Copper)	391-363	
Sandblast Drag Knife 55° / Dia 2 mm (5 pcs)	391-358	
Drag Pouncing Pin Holder	395-313	
Pouncing Pin	391-592	
Pouncing Strip (30 m)	391-598	





Part description	Part number	Picture
Roller Ball Black (5 pcs)	395-430	
Roller Ball Blue (5 pcs)	395-431	
Universal Penholder D – Head	395-434	
Fibre Tip Black Pens (4 pcs)	MP06BK	

TABLE 6-8  
S CLASS 2 ACCESSORIES FOR DRAG SERIES

## T Series

Part description	Part number	Picture
Tangential Knife Holder	395-322	
Standard Tangential Knife 36° (5 pcs)	390-534	
Tangential Knife 60° Sandblast	390-550	
Tangential Double Tip Knife 36°	390-551	
Tangential Knife 45°, Wedge 40/25°	390-560	
Insertion Tool for Tangential Knife	390-553	
Tangential Drag Knife Holder	395-323	
Standard Drag Knife 36° / Dia 1.5 mm (5 pcs)	9TL89-67041	
Drag Knife 60° / Dia 1.5 mm	391-231	

Part description	Part number	Picture
Pouncing Kit S Class T Models	395-315	
Pouncing Pin	391-592	
Pouncing Strip (30 m)	391-598	
Tangential Ballpoint Holder	395-324	
Tangential Ballpoint Pen	395-325	
Assy Fiber Pen S Class T-HD	395-376	
Nose Piece for Drag Knife	395-330	
Nose Piece for Sandblast Knife	395-347	
Nose Piece for Standard Knife	395-348	

TABLE 6-9  
S CLASS 2 ACCESSORIES FOR TANGENTIAL SERIES

General Accessories

Part description	Part number	Picture
Fuses T2AH 250V (10 pcs)	KIT-1040	
Razor Blades (10 pcs)	391-146	
Razor Blades Holder	1NC40-67035	
Set of 2 Core Holders 3"	1NC40-67034	
Pinch Roller Set (2 pcs) & Clips	395-401	
USB Cable A/B, 5M	399-111	
Set of 2 Core Holders 2"	400-561	
Power Cable	(Regional differences, contact local dealer for exact part number)	
Cutting Strip	1NC40-67032	

TABLE 6-10  
S CLASS 2 GENERAL ACCESSORIES