

SBTM
SERIES



User Manual
Rev 001



Notice

Summa reserves the right to modify the information, contained in this User Manual, at any time without prior notice. Unauthorized copying, modification, distribution or display is prohibited. All rights reserved.

Copyright © Summa NV

Registering Your Cutter

Please register your cutter on the following link:

<https://www.summa.com/support/product-registration/>

Contact Information

All inquiries, comments or suggestions concerning this and other Summa manuals should be directed to:

Summa, nv

Rochesterlaan 6
B-8470 GISTEL
Belgium

www.summa.com

Summa America

100 Cummings Center Suite #151-G
Beverly MA 01915
USA

www.summa.com/en-us

+1-978-522-4765

Revision history

Version	Reason for modification	Publication date	Author
001	Original version	5 September 2023	WVL, ALO



Congratulations on your purchase of the new cutter!

The S Class 3 cutter is a state-of-the-art device designed for professional users who demand top performance in their cutting applications.

The ability of thru-cutting, kiss-cutting and creasing without the need for tool changes proves the cutter's versatility. Your workspace may be limited, your output options are not.

Unrivalled tracking delivers guaranteed accuracy on cuts up to 16 meters (52 feet) long. This way you won't have to monitor your cuts, even when you're sending through long jobs.

The S Class 3 range features Summa's advanced True Tangential Cutting Technology with a unique motorised knife, allowing the cutters to achieve unparalleled accuracy and precision down to the smallest details.

In short, the S Class 3 cutter takes cutting signs to a new level.

This manual is a reference guide for installing and operating the S Class 3 series cutters.



Table of Contents

1	Setup	1-1
1.1	Safety	1-1
1.1.1	General	1-1
1.1.2	Symbols used in the manual	1-1
1.1.3	Safety precautions	1-2
1.1.4	Electrical shock hazard	1-3
1.1.4.1	Grounding (“Earthing”)	1-3
1.1.4.2	Operating voltage	1-3
1.1.5	Warning labels on the machine	1-4
1.1.6	Operating environment	1-5
1.2	S Class 3 Cutter Components	1-6
1.2.1	The Cutter as viewed from the front	1-6
1.2.2	The Cutter as viewed from the back	1-7
1.2.3	Models (head types)	1-9
1.2.3.1	D models	1-9
1.2.3.2	T models	1-9
1.2.3.1	TC models	1-10
1.3	Powering on the cutter	1-11
1.4	Connecting the Cutter to a Computer	1-12
1.4.1	USB connection	1-12
1.4.1.1	Connecting the S Class 3 cutter to a PC, using a USB cable	1-12
1.4.1.2	Connecting the S Class 3 cutter to a Mac, using a USB cable	1-13
1.4.2	Wired Ethernet connection	1-13
1.4.2.1	Use static address	1-13
1.4.2.2	Use DHCP server	1-15
1.4.3	Wi-Fi (optional – region dependent)	1-16
1.4.3.1	Default setting	1-16
1.4.3.2	Fixed IP address setting	1-17
1.5	Loading Media	1-19
1.5.1	Pinch roller positioning	1-19
1.5.2	How to Set the Pressure of the Outer Pinch Rollers	1-20
1.5.3	How to Activate or Deactivate the Middle Pinch Roller(s)	1-21
1.5.4	Loading media	1-22
1.6	Tool Installation	1-27
1.6.1	Cutters with drag head	1-27
1.6.1.1	Drag Knife installation	1-27
1.6.1.2	Pen installation	1-31
1.6.2	Cutters with tangential head	1-32
1.6.2.1	Tangential knife installation	1-32
1.6.2.2	Pen installation	1-36
1.6.3	Cutters with performance head	1-37
1.6.3.1	Creasing tool installation	1-37

1.6.3.2	Setting up the second tool	1-37
1.6.4	Replacement of the separation knife blade	1-39
1.7	Activation of Wi-Fi (if available in your region) and the barcode feature	1-40
2	Basic operation.....	2-1
2.1	Touchscreen	2-1
2.1.1	Introduction.....	2-1
2.1.2	Basic operation.....	2-2
2.1.2.1	Control buttons.....	2-2
2.1.2.2	Current settings.....	2-2
2.2	Ease of use.....	2-3
2.3	How to Set Tool Parameters.....	2-4
2.3.1	Setting the tool type.....	2-4
2.3.2	Changing tool pressure	2-5
2.3.3	Changing the drag knife offset.....	2-6
2.3.4	Calibrating a tangential knife.....	2-7
2.3.4.1	Calibrating	2-7
2.3.4.2	Making corrections	2-9
2.4	How to Set the Cutting Speed	2-11
2.5	How to Change the User (Quick Parameter Change)	2-12
2.6	How to Make Sure the Sign Has the Correct Size	2-13
2.7	FlexCut for cutting through.....	2-15
2.7.1	Procedure	2-15
2.7.2	Practical tips.....	2-18
2.7.2.1	Physical knife depth tangential knife	2-18
2.7.2.2	Physical knife depth drag knife	2-19
2.7.2.3	Values of the FlexCut parameters	2-20
2.7.2.4	Material without backing	2-21
3	OPOS.....	3-1
3.1	Introduction.....	3-1
3.2	Basic OPOS operation.....	3-1
3.2.1	Printing the graphic.....	3-2
3.2.2	Different OPOS alignment methods.....	3-3
3.2.3	Processing long jobs	3-4
3.3	Automating OPOS tasks.....	3-5
3.3.1	Cutting multiple copies of a graphic on the same roll.....	3-6
3.3.2	Cutting the same graphic on multiple media sheets	3-8
3.3.3	OPOS Barcode	3-10
3.3.3.1	Introduction.....	3-10
3.3.3.2	Initiating the barcode procedure	3-11
3.4	Calibrating OPOS	3-12
3.4.1	OPOS offset calibration	3-12
3.4.2	Calibrate media (OPOS)	3-13
3.5	OPOS CAM on the TC models	3-15
3.5.1	Standard print and cut jobs	3-15
3.5.2	Extra features OPOS camera	3-15

4	Detailed operation	4-1
4.1	Introduction.....	4-1
4.2	Main menu	4-1
4.2.1	Tool* pressure.....	4-1
4.2.2	Tool* calibration.....	4-1
4.2.3	FlexCut.....	4-2
4.2.4	Tool.....	4-2
4.2.5	Submenus.....	4-2
4.3	Actions.....	4-3
4.3.1	Confidence test	4-3
4.3.2	Open File (USB stick)	4-3
4.3.3	Load media	4-4
4.3.4	Load wider	4-4
4.3.5	Cut off.....	4-4
4.3.6	Cut off sheets	4-4
4.3.7	Recut.....	4-4
4.3.8	Sheet mode.....	4-4
4.4	Settings.....	4-5
4.4.1	Velocity.....	4-5
4.4.2	Overcut	4-5
4.4.3	Multipass	4-5
4.4.4	OptiCut.....	4-5
4.4.5	TurboCut.....	4-6
4.4.6	Panels	4-6
4.4.7	Sorting	4-6
4.5	Calibrations	4-7
4.5.1	Calibrate media (OPOS)	4-7
4.5.2	Calibrate OPOS offset.....	4-7
4.5.3	Calibrate media sensors.....	4-7
4.5.4	Length calibration	4-9
4.6	Configuration.....	4-10
4.6.1	Ethernet.....	4-10
4.6.2	Wi-Fi.....	4-10
4.6.3	USB Port	4-10
4.6.4	Language	4-10
4.6.5	Menu units	4-10
4.6.6	Factory defaults.....	4-11
4.6.7	Autoload	4-11
4.6.8	Recut offset	4-11
4.6.9	Media sensor	4-11
4.6.10	Roll up media	4-11
5	Maintenance.....	5-1
5.1.1	Cleaning the drive system.....	5-1
5.1.2	Cleaning the media sensors.....	5-2
5.1.3	Cleaning the nosepiece (tangential machine only)	5-3
5.1.4	Cleaning the Y guiding rail	5-4
5.1.5	Changing the fuse	5-5

6	Specifications	6-1
6.1	Introduction.....	6-1
6.1.1	Models	6-1
6.1.2	Feature List.....	6-1
6.1.2.1	Hardware	6-1
6.1.2.2	Interface	6-2
6.1.2.3	Functionality	6-2
6.1.2.4	Software.....	6-2
6.1.3	Accessories.....	6-3
6.2	Technical Specifications.....	6-5
6.2.1	Machine dimensions	6-5
6.2.2	Shipping dimensions	6-5
6.2.3	Media handling	6-6
6.2.4	Performance	6-7
6.3	Noise level.....	6-7
6.3.1	Interface	6-8
6.3.2	Firmware.....	6-8
6.3.3	Environmental	6-8
6.3.4	Electrical.....	6-9
6.3.5	Certifications	6-9

List of Figures

1-1 Example of Properly grounded plug-socket combination	1-3
1-2 S Class 3 cutter front view	1-6
1-3 S Class 3 cutter rear view.....	1-7
1-4 S Class 3 toolhead for drag knife	1-9
1-5 S Class 3 toolhead for tangential knife	1-9
1-6 S Class 3 toolhead for tangential knife	1-10
1-7 S Class 3 tool shafts	1-10
1-8 Media is loaded and the cutter is ready	1-11
1-9 Cutter is ready and no media is loaded	1-11
1-10 Reducing pressure	1-20
1-11 ACTIVATE PINCH ROLLERS	1-21
1-12 Pinch roller lever	1-22
1-13 Core holders	1-22
1-14 Position FLANGES.....	1-22
1-15 Feeding roll media without using the core holders	1-23
1-16 PINCH ROLLERS POSITION	1-23
1-17 Media position	1-24
1-18 Pinch roller lever	1-25
1-19 Removing the drag knife holder from the clamp	1-27
1-20 Removing the knife from the standard drag knife holder	1-27
1-21 Knife length adjustment	1-28
1-22 Clamp drag head	1-28
1-23 Knife pressure test pattern	1-29
1-24 Peeled Knife pressure test pattern	1-30
1-25 Knife is chosen tool	1-31
1-26 Pen is chosen tool	1-31
1-27 Removing the tangential knife holder	1-32
1-28 Removing the knife from the tangential knife holder	1-32
1-29 Blade assembly.....	1-33
1-30 Inserting the tangential knife holder	1-33
1-31 Knife depth adjustment	1-33
1-32 Knife pressure test pattern	1-34
1-33 Peeled Knife pressure test pattern	1-34
1-34 Inserting the creasing tool.....	1-37
1-35 touch screen on a TC model.....	1-37
1-36 Razor blade for automatic separation of media.....	1-39
2-1 Touchscreen	2-1
2-2 Possible screen saver display.....	2-1
2-3 Blue parts.....	2-3
2-4 Blue status light.....	2-3
2-5 Red status light.....	2-3
2-6 Green status light	2-3
2-7 Knife pressure test pattern	2-5
2-8 PEELED TEST PATTERN	2-5
2-9 Correct mesoffset-patnoon.....	2-6
2-10 Correct tangential knife calibration test	2-8
2-11 Possible knife calibrations.....	2-9
2-12 Length calibration pattern	2-14

2-13 Flexcut principle	2-15
2-14 Knife depth setting normal cutting	2-18
2-15 Knife depth setting cutting through.....	2-18
2-16 Knife depth setting normal cutting	2-19
2-17 Knife depth setting cutting through.....	2-19
3-1 Margins printing on a roll	3-2
3-2 Margins printing on a sheet.....	3-2
3-3 OPOS alignment methods.....	3-3
3-4 Positioning the media for multiple sheets.....	3-9
3-5 OPOS barcode Job loaded	3-10
4-1 Main menu	4-1
4-2 Action menu.....	4-3
4-3 Settings menu.....	4-5
4-4 Overcut	4-5
4-5 Calibrations menu.....	4-7
4-6 Back sensor for media detection.....	4-7
4-7 Load media for sensor test.....	4-9
4-8 configuration menu	4-10
5-1 Cleaning sleeves	5-1
5-2 Media sensors S Three cutters	5-2
5-3 Removing the tangential knife holder	5-3
5-4 Nose piece	5-3
5-5 Sliding surfaces on Y guidING rail.....	5-4
5-6 Power entry module.....	5-5

1.1 Safety

1.1.1 General

The purpose of the user's manual is not only to explain the operating procedures of this machine, but it also provides the owner, users, and operators with precaution procedures for safe and proper machine operation for its intended purpose. All information in this manual must be read and understood before any attempt is made to operate the machine.

The manufacturer has no direct control over the machine operation and application. Proper safety practice is the sole responsibility of the owner, user, and operator. All instructions and safety warnings in this manual are based upon the use of this machine under proper operating conditions without alterations from the original design.

Any use of the cutter that is beyond the capabilities of the combination knife/material is considered as improper use and may result in injury and serious damage to the machine and will lead to loss of warranty.

1.1.2 Symbols used in the manual



Warning with dark (red) symbol: Refers to immediate threat that can cause serious injuries and effects on health and safety.



Warning with light (yellow) symbol: Refers to a dangerous situation that can cause injuries and serious damage to the machine.



Attention with dark (red) symbol: Refers to useful information to prevent damage to the equipment and prolong the service life of the machine.



Attention with light (yellow) symbol: Refers to useful tips to enhance the user friendliness and make the work significantly easier.



Note: Can be considered as a general tip; something that is useful to know.

1.1.3 Safety precautions



WARNING: This equipment is not suitable for use in locations where children are likely to be present.



WARNING: The S Class 3 cutters use razor-sharp knives. Touching the knife with bare hands may cause injury. Do not touch the knives while the machine is cutting.

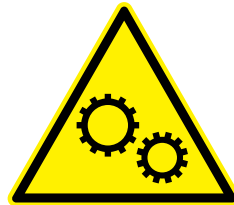

WARNING: There is a risk of injury from being caught or trapped in moving machine parts. Keep hands, hair, clothing and jewellery away from moving parts. Do not wear jewellery, loose clothing, scarves, open jackets or shirtsleeves.

The entire base plate should be considered as a dangerous area when the cutter is switched on and off. The tool carriage can move from the left to the right and the media grit rollers are sharp and can grab loose objects, clothing or body parts.



NOTE: Make sure to observe all the caution labels on the cutter.

The cutter constantly measures the current through the motors. If the machine detects the current is too high, then the current will be cut off to the motors and a fatal error message will be displayed on the control panel.

There are no user-serviceable parts inside the S Class 3 cutters. For servicing refer to qualified personnel only.

Turn off the cutter and contact a service representative in any of the following cases:

- There is visible mechanical damage.
- The power cord is damaged.
- The cutter has been damaged by an impact.
- Liquid was spilt on the cutter.
- There is a strange noise, smoke or an unusual smell coming from the cutter.
- The cutter has been dropped.

1.1.4 Electrical shock hazard

1.1.4.1 Grounding ("Earthing")



WARNING: The wall sockets, into which the cutter is plugged-in, must be of the grounded type. The grounded conductors, serving the wall socket, must be properly connected to the ground.

For emergency access, the cutter should be installed near the socket-outlet for easy access.

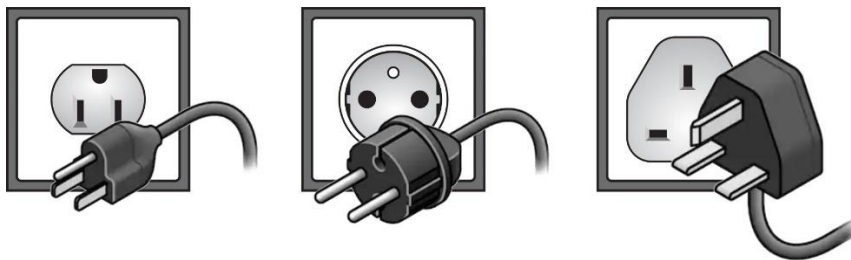

FIG 1-1
EXAMPLE OF PROPERLY GROUNDED PLUG-SOCKET COMBINATION

1.1.4.2 Operating voltage

The power supply detects the line voltage and switches automatically between 100V and 240V.



WARNING: The built-in power supply operates at hazardous voltages capable of causing serious injury or death. Unplug the equipment when not used for an extended period.



WARNING: Before changing the fuse(s), make sure that the cutter is completely disconnected from its power source.



WARNING: For continued protection against risk of fire, replace only with fuse of the same type and having the same electrical rating: T2AH 250V.

1.1.5 Warning labels on the machine

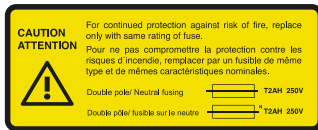

Warning label regarding the fuse. For continued protection against risk of fire, replace only with fuse of the same type and having the same electrical rating: T2AH 250V.

Double pole/neutral fusing.

This label is located near the power inlet, on the rear.

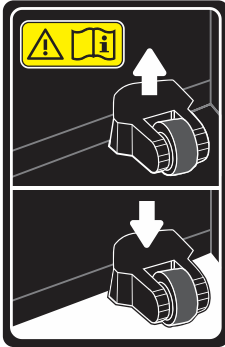

Caution: Always leave the pinch rollers in the upper position when the cutter is not in use.

This label is located on the right side plate.



The S Class 3 cutters use razor-sharp knives. Touching the knife with bare hands may cause injury.

Hazardous moving part. Keep your fingers and other body parts away from this area.

This label is located on the cutting head.

1.1.6 Operating environment

Environmental conditions can significantly affect the machine's performance. The environmental conditions of the machine (without media) are as follows:

Operating Temperature	15 to 35° C	59 to 95° F
Storage temperature	-30 to 70° C	-22 to 158° F
Relative humidity	35 - 75 %, non-condensing	35 - 75 %, non-condensing

The environmental conditions of the used media may be stricter than those of the machine itself. Please refer to the documentation about the used media.

Moreover, make sure that the media has had enough time to acclimatize.



NOTE: Keep the cutter away from direct sunlight or a strong indoor light source. The optical sensors in the machine may be affected, thus causing unexpected behaviour of the cutter.

1.2 S Class 3 Cutter Components

1.2.1 The Cutter as viewed from the front

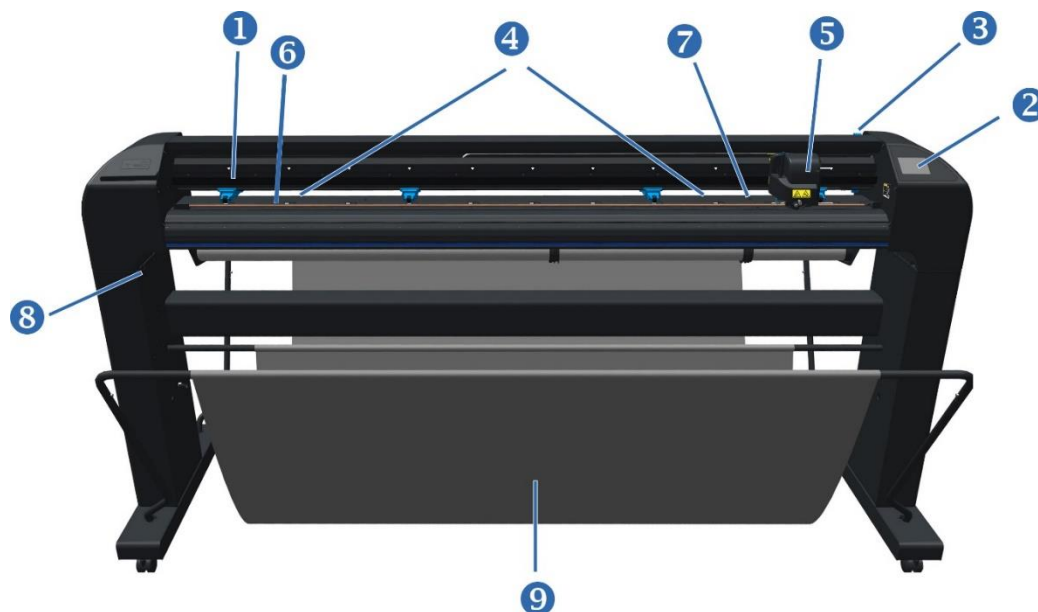

FIG 1-2
S CLASS 3 CUTTER FRONT VIEW

- 1. Pinch rollers:** The pinch rollers clamp the media to the grit rollers to ensure accurate tracking. Larger models have one or two pinch rollers in the middle to ensure that wide media stays flat in the middle. These pinch rollers can be enabled/disabled, while of the outer pinch rollers the pressure is adjustable. It is possible to install additional pinch rollers that will function the same as any middle pinch rollers already provided.
- 2. Touchscreen:** All cutter activity can be initiated from the touchscreen. It displays information about the cutter's current status and/or actions that need to be taken.
- 3. Pinch roller lever:** This lever is used to raise and lower the enabled pinch rollers for media loading.
- 4. Media grit rollers:** The media grit rollers only move the media when the pinch rollers are lowered. The larger the model, the more small rollers.
- 5. Tool carriage:** The tool carriage is the mount for the knife holder, pen or pouncing tool. It also holds the Optical POSitioning sensor (OPOS).
- 6. Cutting strip:** A self-healing orange strip helps avoiding damage to the knife tip when no media is loaded. Since cutting is done on the cutting strip, the strip must remain intact.
- 7. Media sensor:** A media sensor behind the right grit roller is used to detect the end of the loaded media.
- 8. Screws to secure the cutter base:** Make sure all screws are secured at each side before using the cutter.
- 9. Media basket** to recover the cut material.

1.2.2 The Cutter as viewed from the back

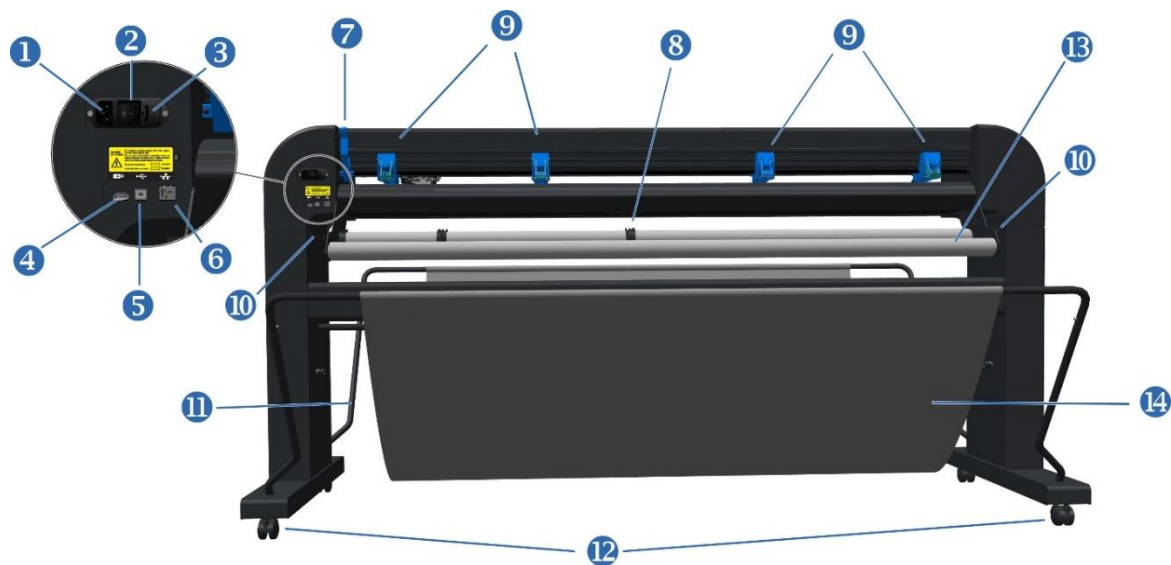

FIG 1-3
S CLASS 3 CUTTER REAR VIEW

1. **AC power cord receptacle:** It is located at the left-hand side of the power entry module. The power-up procedure is explained in detail in section 1.3. Always use the power cord that is delivered with your cutter.
2. **Power On/Off switch:** This rocker switch, located in the middle of the power entry module, sets the cutter's power on ("I") or off ("O").
3. **Fuse:** The fuse is located at the right side of the power entry module. Check the specification section to see which fuse is used in the S Class 3 cutter.



WARNING: For continued protection against the risk of fire, replace only with the same type and rating of fuses: T2AH 250V.

4. **USB port type A female:** For plugging in a USB stick.
5. **Ethernet port RJ45:** For connecting the cutter to the LAN.
6. **USB port Type B female:** This interface is based on the standards, specified in the Universal Serial Bus Specifications Revision 1.1. It allows a high-speed bi-directional communication between the host computer and the cutter.
7. **Pinch roller lever:** This lever is used to raise and lower the enabled pinch rollers for media loading.
8. **Roll media guide bushes:** The two guide bushes keep the media roll in place when media is pulled from the roll.

- 9. Pinch rollers:** The pinch rollers clamp the media to the grit rollers to ensure accurate tracking. Larger models have one or two pinch rollers in the middle to ensure that wide media stays flat in the middle. These pinch rollers can be enabled/disabled, while of the outer pinch rollers the pressure is adjustable. It is possible to install additional pinch rollers that will function the same as any middle pinch rollers already provided.
- 10. Screws to secure the cutter base:** All the screws must be properly secured before using the cutter.
- 11. Tubes for the media basket:** Tubes in the back and front hold the media basket. They can easily be pulled outwards (open) to put the basket in its place.
- 12. Casters:** The casters on the stand are equipped with locking brakes. When the cutter has been moved to its new location, press the brakes with your foot to lock the casters.
- 13. Media support rollers:** Rotating support rollers for the media roll.
- 14. Media basket** to recover the cut material.

1.2.3 Models (head types)

There are 3 different models available within the range of the S series. They can be identified by the type of tool head.

1.2.3.1 D models

The D models are equipped with a head for drag knives. The drag knife can be replaced by a pen.



FIG 1-4
1-4 S CLASS 3 TOOLHEAD FOR DRAG KNIFE

1.2.3.2 T models

The T models are equipped with a head for tangential knives. The tangential knife can be replaced by a drag knife or a pen.



FIG 1-5
1-5 S CLASS 3 TOOLHEAD FOR TANGENTIAL KNIFE

1.2.3.1 TC models

The TC models are equipped with the dual (performance) head. At first glance, the dual head looks a lot like the standard tangential head for the T models. However, the performance head has two distinct features.

1. The standard OPOS sensor on this head is a camera for faster registration of the marks.
2. There is also the possibility to mount two tools simultaneously, so jobs that require multiple tools do not have to be paused for a tool change. Additionally, a creasing tool can be mounted as a second tool.

The difference between a standard tangential head and a performance head becomes clear when a print and cut job is started. The standard tangential head will lower an OPOS sensor onto the media to read the registration marks. In contrast, the performance head will activate a light that will be clearly visible to ensure the built in camera recognizes the registration marks.



FIG 1-6

1-6 S CLASS 3 TOOLHEAD FOR TANGENTIAL KNIFE

The performance head has two tool shafts allowing for the installation of two tools simultaneously. The rear tool shaft (❶) is clearly visible and identical to the standard tangential head. The front tool shaft (❷) only shows the hole; the tool shaft itself is completely enclosed by the cover of the performance head.

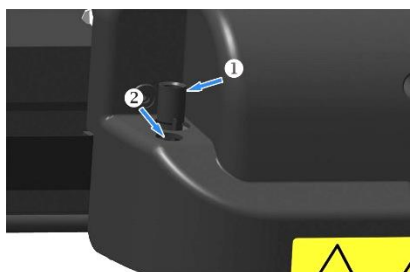

FIG 1-7

1-7 S CLASS 3 TOOL SHAFTS

1.3 Powering on the cutter



WARNING: Make sure the power switch is turned off (“O”) before connecting the power cord.



WARNING: Do not use the power cord if it is visibly damaged. Disconnect the power cord by pulling the **plug**, not the **cable**.



WARNING: Keep fingers and other body parts away from the cutting area. There are hazardous moving parts present.

1. Plug the female end of the AC power cord into the receptacle, located in the power entry module on the cutter's rear panel.
2. Plug the male end of the AC power cord into a properly grounded wall socket.
3. Power on the cutter by pressing **I** on the **I/O** rocker switch, located on the power entry module on the rear panel.
4. The touchscreen will activate, and the initialization process will begin. If media is loaded, the cutter will check the size and load the media.

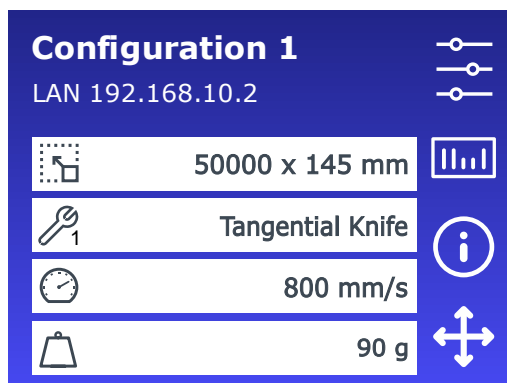

FIG 1-8
MEDIA IS LOADED AND THE CUTTER IS READY

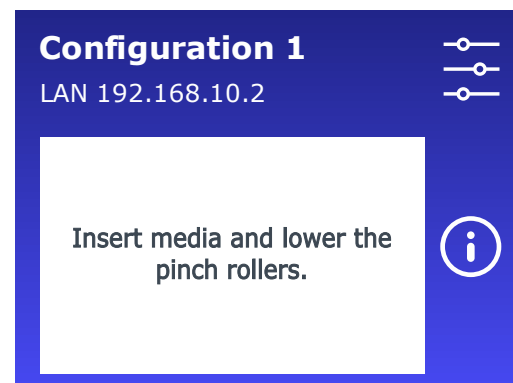

FIG 1-9
CUTTER IS READY AND NO MEDIA IS LOADED

1.4 Connecting the Cutter to a Computer

The S Class 3 cutters feature both an Ethernet port and USB ports. If both the Ethernet port and one of the USB ports are in use, the port that receives the data first remains active and the other port is deactivated.

1.4.1 USB connection

The USB cable should be max. 5 meters (16 feet) long. The connector on the cutter side of the cable should be USB series B 4-pin. The connector on the computer side of the cable should be USB A 4-pin.

1.4.1.1 Connecting the S Class 3 cutter to a PC, using a USB cable



ATTENTION: When installing a cutter, make sure the user has administrative rights and UAC is deactivated or set it to its lowest level.

1. Power off the cutter.
2. Go to www.summa.com/en/support/software-firmware and download and install the USB device driver for the S Class 3 cutter.
3. Wait for the driver to install.
4. Connect one end of the USB cable to a USB port on the computer.
5. Connect the other end of the USB cable to the USB port on the back of the cutter.
6. Power on the cutter and return to the computer.
7. The *Found New Hardware Wizard* should appear on the computer screen and install the USB driver.
8. Click **OK** and follow the instructions, provided by the Wizard.
9. Restart the computer.



ATTENTION: When connecting a cutter to a computer for the first time, using the USB cable, the computer will detect the cutter and install the USB driver if the setup program was run. If the setup program was not run before connection, then install the program while the cutter is connected and switched on. After the program has run, the computer will detect a new device and install the correct driver automatically.



NOTE: To connect more than one cutter to one computer, see section 4.6.3.

1.4.1.2 Connecting the S Class 3 cutter to a Mac, using a USB cable

- Mac OSX

Most recent cutting software do not need a driver installation when a computer is connected to the cutter. The software that controls the driver is built into the cutting software.

1.4.2 Wired Ethernet connection



ATTENTION: The Ethernet cable should be a shielded CAT6 Ethernet cable.

A couple of parameters need to be set when connecting a cutter to the Ethernet. It is best to ask the network administrator whether a static address is needed or if a DHCP server is used. If a static address is used ask for the address and the subnet mask.

1.4.2.1 Use static address

The static address that you received will be used in the software to drive the cutter. It has also to be set in the cutter itself.



NOTE: It is recommended to use a static IP address.

1. Connect the Ethernet cable and power on the cutter (see section 1.3).

2. Tap .

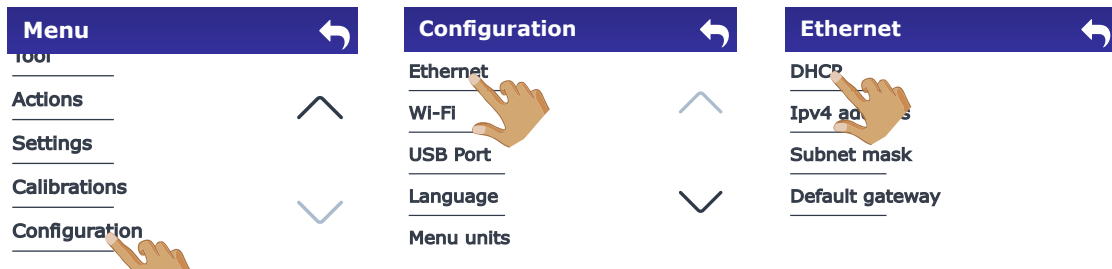

3. Scroll down with the arrow and tap **Configuration**.
4. Tap **Ethernet**.
5. Tap **DHCP**.

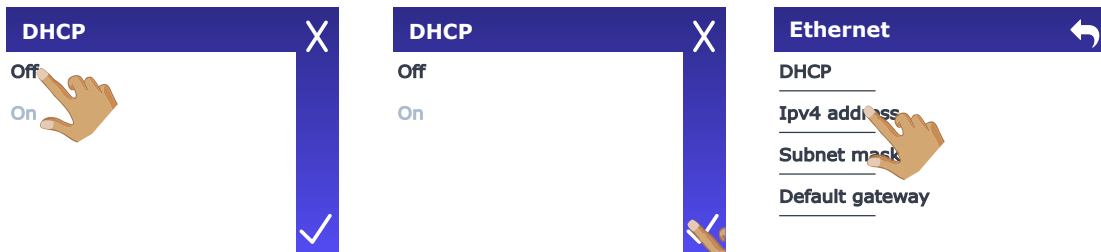

6. Tap **Off**.
7. Tap  to confirm.
8. Tap **IPv4 address**.



9. Set the address correctly.

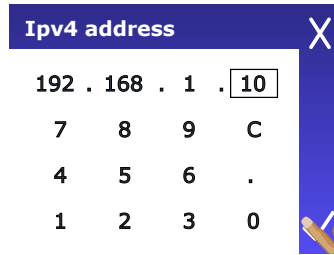

10. Tap  to confirm.

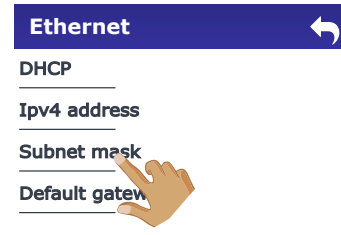

11. Tap **Subnet mask**.

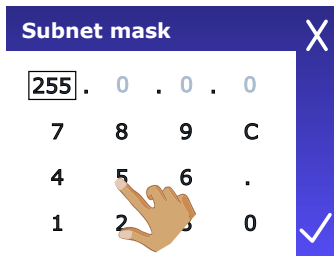

12. Set the address correctly.

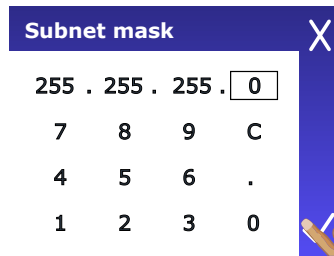

13. Tap  to confirm.

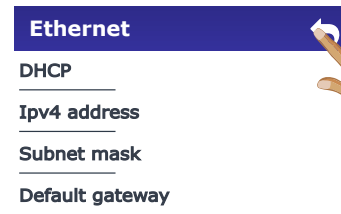

14. Tap  to leave.

15. Reboot the cutter.

1.4.2.2 Use DHCP server

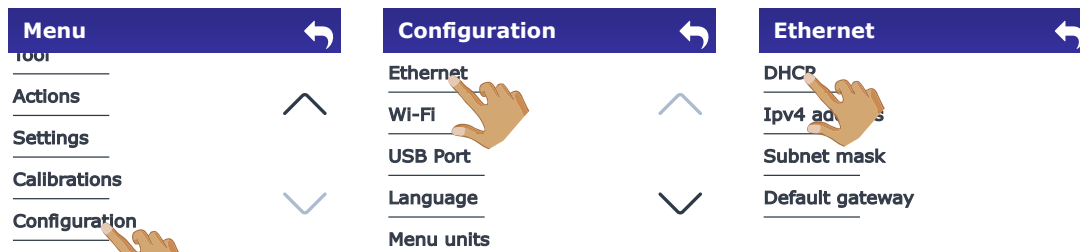

1. Connect the Ethernet cable and power on the cutter (see section 1.3).

2. Tap .

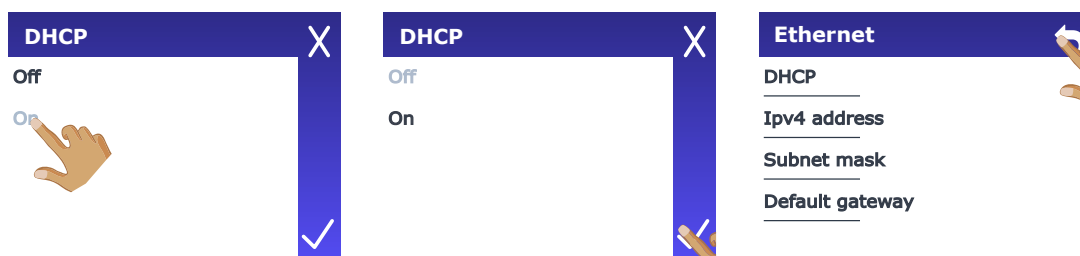

3. Scroll down with the arrow and tap **Configuration**.
4. Tap **Ethernet**.
5. Tap **DHCP**.



6. Tap **On**.
7. Tap  to confirm.
8. Tap  to leave.
9. Reboot the cutter.

The assigned IP address should now be visible in the status and can be used in the cutting software.



NOTE: If the DHCP server is used, then the IP address that is assigned to it can be changed if the cutter is not used for a time longer than the lease time set in the DHCP server (check with your IT admin for details).

1.4.3 Wi-Fi (optional – region dependent)



NOTE: The Wi-Fi option is not activated by default. It needs to be activated with a code that also activates the barcode option. Check section 1.7.

Connecting the S Class 3 cutters to Wi-Fi is not possible in every region. If you live in a region where Wi-Fi is not an option, the message “*Wi-Fi not available in your region*” will appear.

1.4.3.1 Default setting

Wi-Fi is default set to use DHCP so you only need to connect to the correct Wi-Fi network that is broadcasting its SSID (network name).

1. Power on the cutter (see section 1.3).

2. Tap .

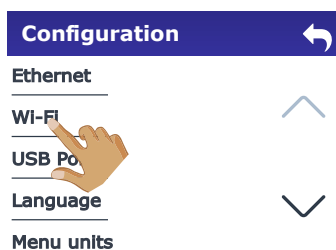
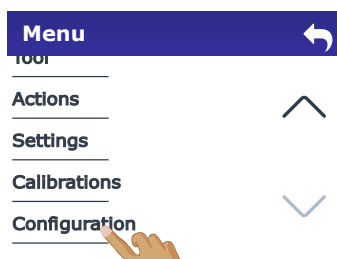

3. Scroll down with the arrow and tap **Configuration**.

4. Tap **Wi-Fi**.

5. Tap **Networks**.

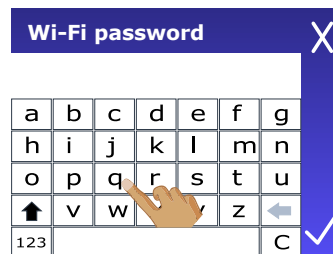
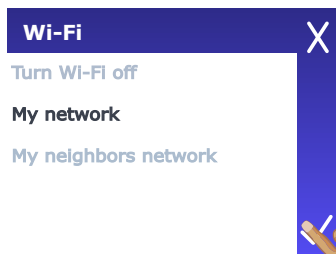
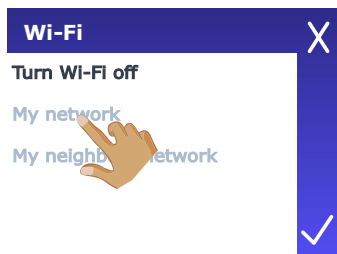

6. Tap the correct network.

7. Tap  to confirm.

8. Enter the password.

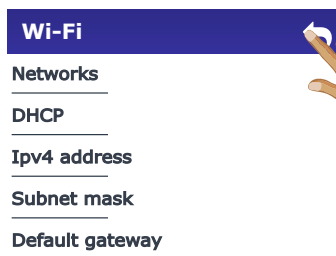
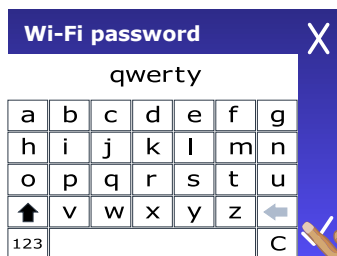

9. Tap  to confirm.

10. Tap  to leave.

1.4.3.2 Fixed IP address setting

Ask the network administrator for the address and the subnet mask if a static address is used.



NOTE: We recommend using a static IP address.

1. Power on the cutter (see section 1.3).

2. Tap .

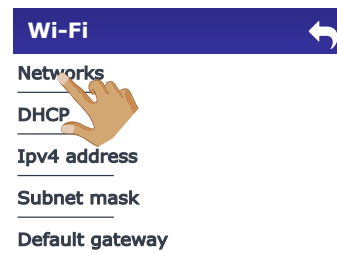
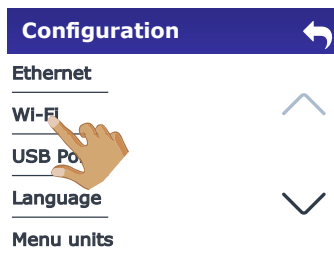
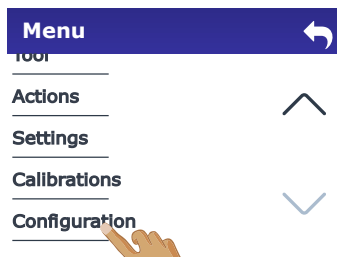

3. Scroll down with the arrow and tap **Configuration**.

4. Tap **Wi-Fi**.

5. Tap **Networks**.

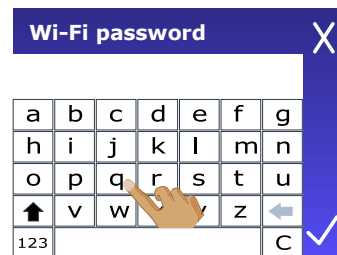
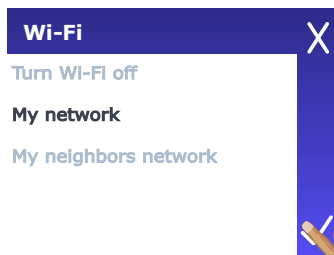
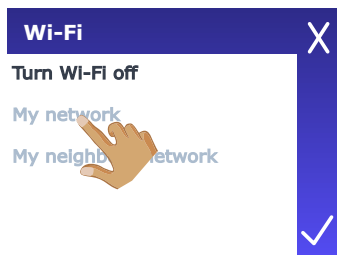

6. Tap the correct network.

7. Tap  to confirm.

8. Enter the password.

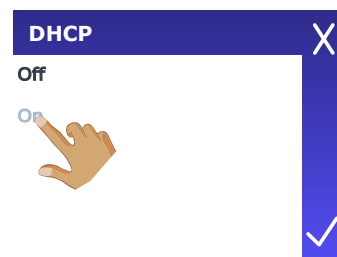
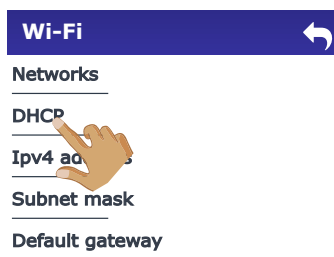
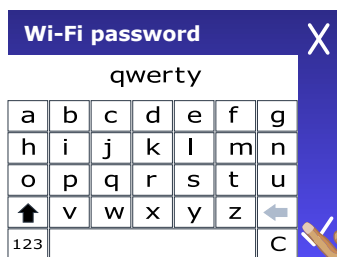

9. Tap  to confirm.

10. Tap **DHCP**.

11. Tap **Off**.

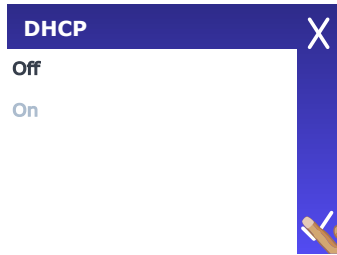

12. Tap  to confirm.

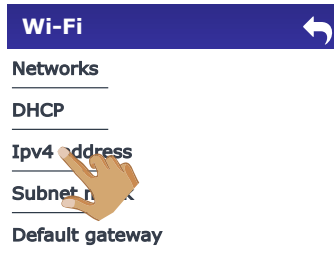

13. Tap **IPv4 address**.

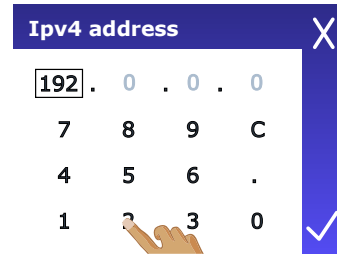

14. Set the address correctly.

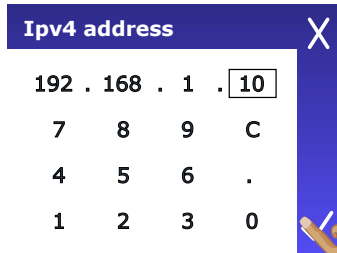

15. Confirm by tapping .

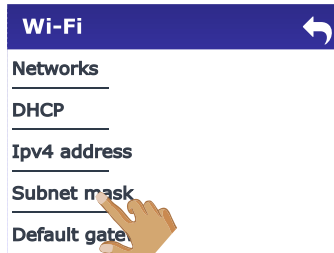

16. Tap **Subnet mask**.

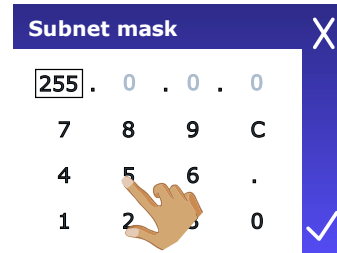

17. Set the value correctly.

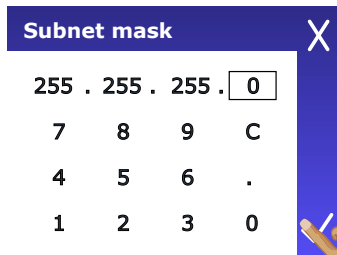

18. Confirm by tapping .

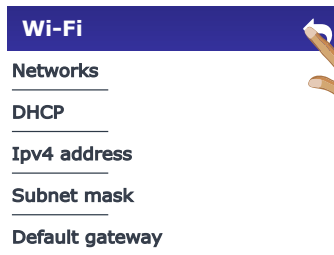

19. Tap  to leave.

1.5 Loading Media

The following procedures mainly apply to the use of roll media. If you are using sheets, there are two options:

1. For long sheets: roll up the sheet, so that the alignment is identical to that of a roll.
2. For short sheets: the alignment is not very important. If the sheet is cut off perpendicularly, it can be aligned to the front border.

1.5.1 Pinch roller positioning

The pinch rollers must first be correctly positioned before an automatic loading procedure can be started. Correct positioning of the pinch rollers is crucial for controlled movement of the material.

The pressure of the outer two pinch rollers (left and right) can be changed (see section 1.5.2). The middle pinch roller(s) can be enabled or disabled (see section 1.5.3). All enabled pinch rollers are simultaneously lowered or raised using the lever arm located on the right at the back of the cutter.



ATTENTION: Always leave the pinch rollers in the upper position when the cutter is not in use. If you leave the pinch rollers down for a long time, they become flattened at the bottom, which seriously affects throughput performance and cut quality.



NOTE: When the pinch rollers are raised during a job, the cutter will immediately stop and move the carriage to the right side.

1.5.2 How to Set the Pressure of the Outer Pinch Rollers

The pressure of the S Class 3 cutters pinch rollers can be standard or low. The pressure should only be changed when the pinch rollers are lowered. When reduced pressure is needed, it is advised to set **Autoload** to **Ask**. In this case, the cutter does not automatically start loading vinyl after it was switched on or after the pinch rollers were lowered; a message appears on the touchscreen to adjust the pressure of the pinch rollers.



NOTE: Each time after lifting the pressure rollers, the pressure is automatically reset to standard.

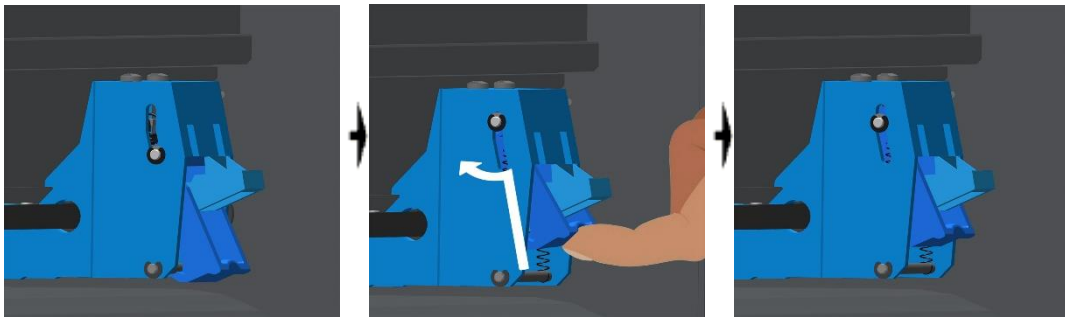

FIG 1-10
REDUCING PRESSURE

To cut with reduced pressure, do the following:

1. Set **Autoload** to **Ask** (see section 4.6.7).
2. Load the media in the cutter (see section 1.5.4).
3. Push the cap of the two outer pinch rollers upwards and inwards (toward the machine) – see figure above.

1.5.3 How to Activate or Deactivate the Middle Pinch Roller(s)

When the middle pressure rollers are enabled (see figure below), they are raised or lowered together with the two outer pressure rollers when the lever arm is operated. When disabled, they remain raised.

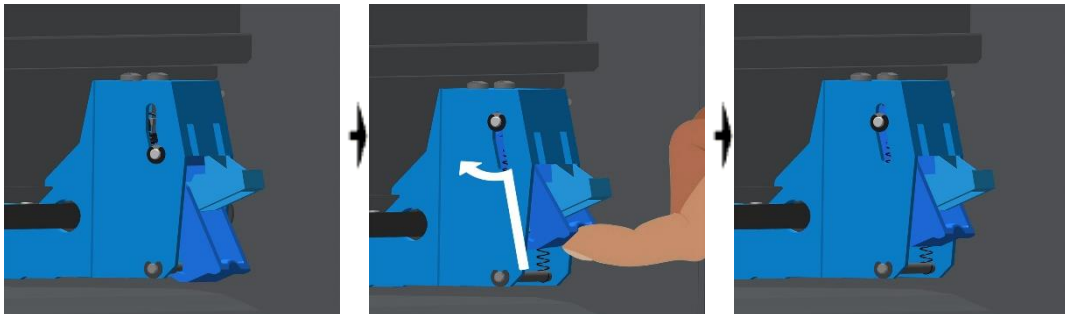

FIG 1-11
ACTIVATE PINCH ROLLERS

1.5.4 Loading media

1. Raise the pinch rollers by lowering the pinch roller lever arm, located at the right-hand side of the cutter, next to the touch panel.

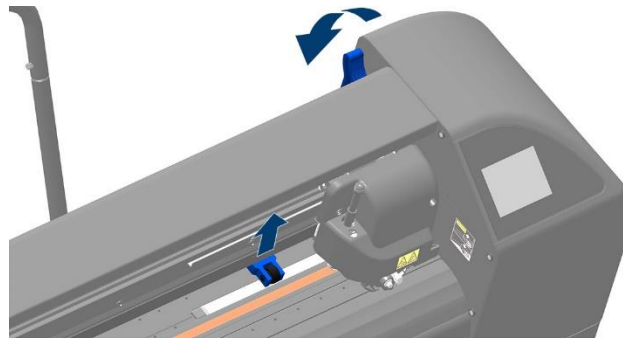

FIG 1-12
PINCH ROLLER LEVER

2. Loosen the knobs on the two media flanges. The following illustration shows a loosened flange ❶ and a tightened flange ❷.

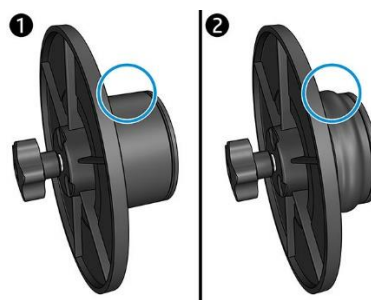

FIG 1-13
CORE HOLDERS

3. Insert a loosened flange into one end of the media roll and tighten the knob. Verify that the flange is secure. Then do the same at the other side of the roll.
4. Place the material roll with tightened flanges on the material support rollers in the grooves of the flange guides. You can move the flange guides if necessary.

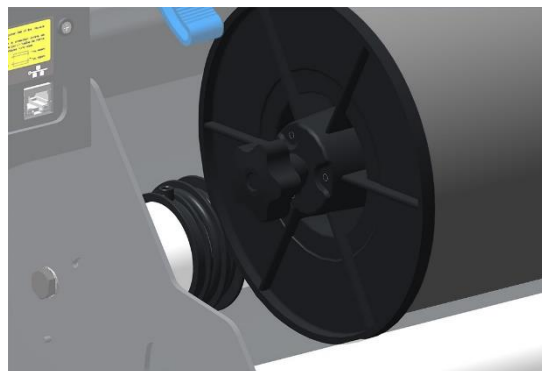

FIG 1-14
POSITION FLANGES



ATTENTION: If the flanges are not used (not recommended as this does not ensure that the material will be fed through accurately), make sure the roller is between the two flange guides.

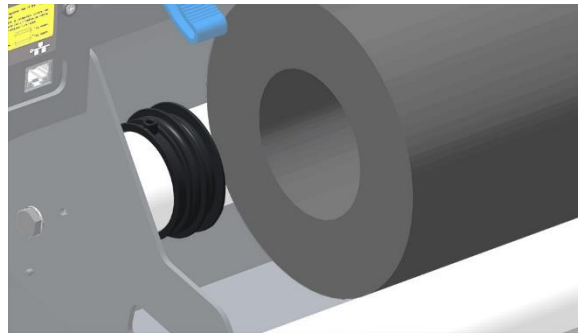

FIG 1-15
FEEDING ROLL MEDIA WITHOUT USING THE CORE HOLDERS

5. Start feeding the media from the rear of the machine. Pass the media underneath the pinch rollers towards the front of the machine.
6. Place the material with the left material edge on the far-left grit roller and make sure the right material edge lies over the long grit roller.
7. Position the left and right pinch rollers above the grit rollers in a click position, each about 3 to 15 mm (0.1" to 0.6") from the outer edges of the material. The right pinch roller should be clicked above the longest grit roller.

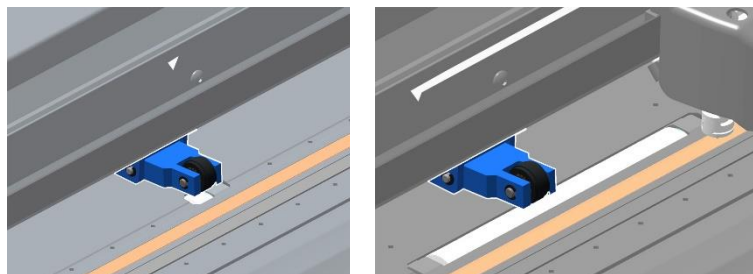

FIG 1-16
PINCH ROLLERS POSITION



ATTENTION: When sliding the pinch rollers, hold them by their sides along the front (not the back) of the cutter.

8. From the front of the cutter, gently pull on the material while holding the flange so that the material is tight.

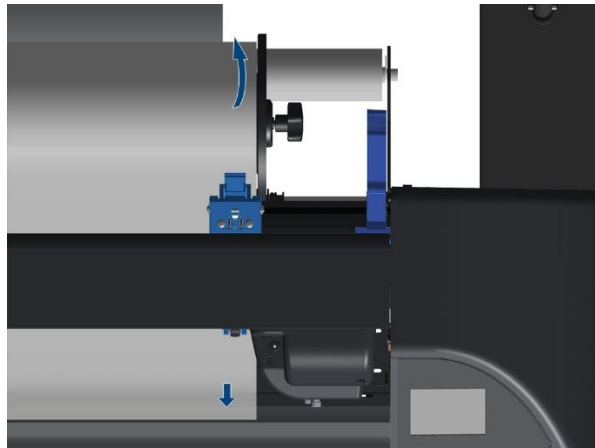
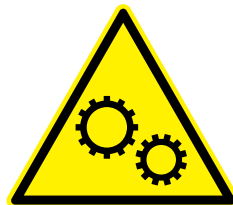

FIG 1-17
MEDIA POSITION

When the above procedure does not work, e.g., because the media is too narrow to reach the long grit roller, try positioning the left media edge over the second left grit roller and positioning the right media edge somewhere over the long grit roller. Continue moving the left pinch roller towards the long grit roller until both pinch rollers are in their designated position and directly over the edges of the vinyl.

In any case, both edges of the media must cover a grit roller. If this is not the case, reposition the material roll to cover the grit roller.

9. Make sure the media follows a straight path from the roll to the cutter. To accomplish this, slide the media roll and the flange guides along the media support rollers if necessary.



WARNING: Keep fingers and other body parts away from the cutting area. There are hazardous moving parts present.

10. Raise the pinch roller lever to press the media firmly against the grit rollers. After one second the tool carriage automatically moves from the right to the left to sense the usable media width.

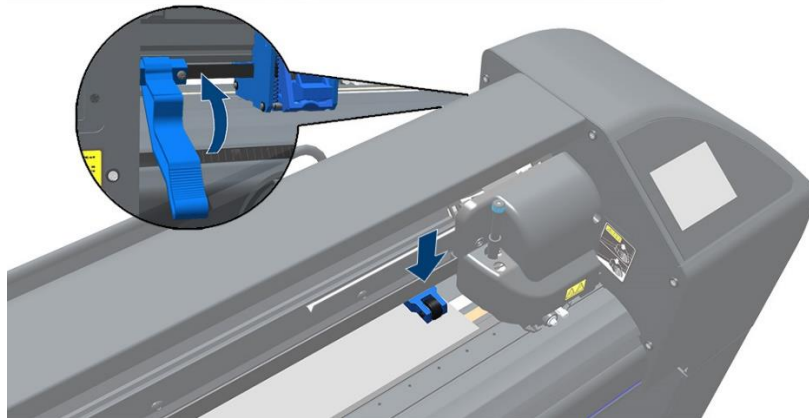

FIG 1-18
PINCH ROLLER LEVER





ATTENTION: We do not recommend unrolling the media manually from the roll. The cutter automatically unrolls the media during the load sequence.

11. The positioning and routing of sheet material is identical to that of roll media.
12. The cutter is now operational.

➤ **Changing origin.**

1. Power on the cutter and load the media (see section 1.5).



2. Tap .
3. Use the arrows to change the origin. The value next to **Y** is the width that is left.
4. Tap  to confirm the new origin.

➤ **Load wider.**

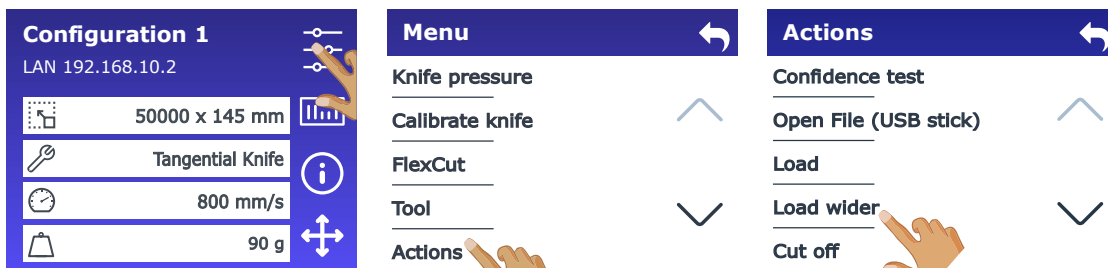

The function **Load wider** makes it possible to redefine the limits of the Y-axis so that the cutter can cut outside the pinch rollers.

1. Power on the cutter and load the media (see section 1.5).

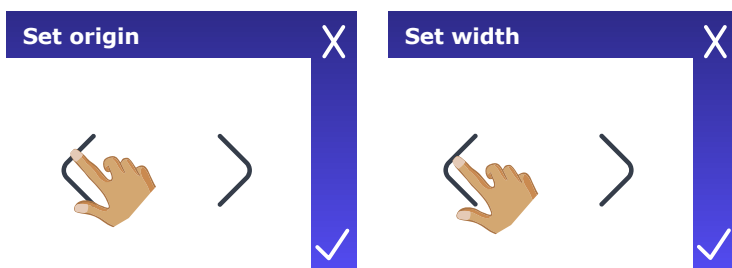

2. Tap .
3. Tap **Actions**.
4. Tap **Load wider**.



5. Set the origin with the arrows and tap  to confirm.
6. Set the size with the arrows and tap  to confirm.



ATTENTION: Accurate tracking is not guaranteed when using this mode.

1.6 Tool Installation



WARNING: The S Class 3 cutters use razor-sharp knives. To avoid serious injury, be careful when installing, removing, or handling the knife!

1.6.1 Cutters with drag head

1.6.1.1 Drag Knife installation

A knife is pre-installed in the cutter. For safety reasons, the knife depth has been set to zero. Turn out the knife before cutting. Please find the complete description of the knife removal and knife installation below.

➤ *Removing the drag knife*

1. Loosen the head clamp screw and remove the knife holder from the clamp.

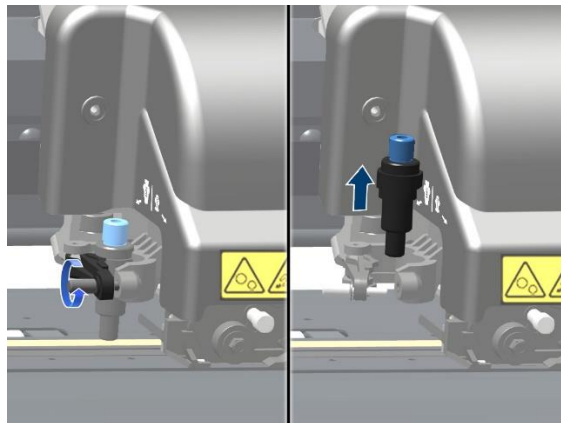

FIG 1-19

REMOVING THE DRAG KNIFE HOLDER FROM THE CLAMP

2. Turn the knurled adjustment knob ① clockwise to push the knife ② out of the holder ③.



FIG 1-20

REMOVING THE KNIFE FROM THE STANDARD DRAG KNIFE HOLDER

3. Carefully pull the knife from the holder.

➤ *Installing the drag knife*

1. Remove the aluminium piece from the plastic knife holder **3** by turning the knurled adjustment knob **1** counterclockwise until the aluminium piece comes out of the holder.
2. Insert the conical, non-cutting end of the knife into the opening in the narrow end of the holder. Gently push the knife in.
3. Turn the holder upside down and gently tap it on a solid surface to ensure the knife is completely inserted.
4. Slowly turn the knurled knob clockwise until the tip of the blade extends as far as required to cut the desired media (t), as shown in the figure below.

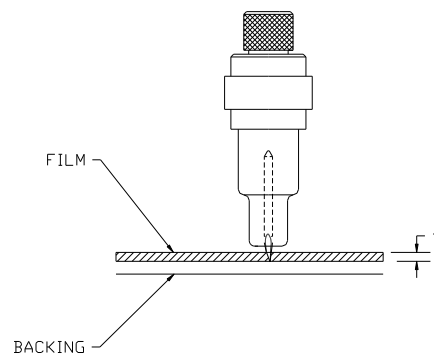

FIG 1-21
KNIFE LENGTH ADJUSTMENT

5. Insert the knife holder into the head clamp and push it down (left picture).

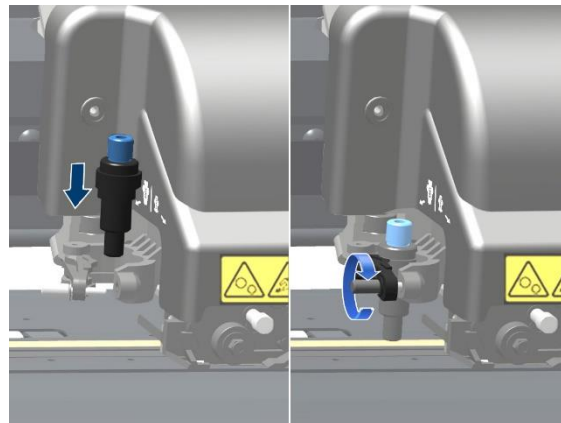

FIG 1-22
CLAMP DRAG HEAD

6. Tighten the clamp screw (right picture).

Setting knife depth and pressure

(The media must be loaded in the cutter before the knife pressure can be tested).



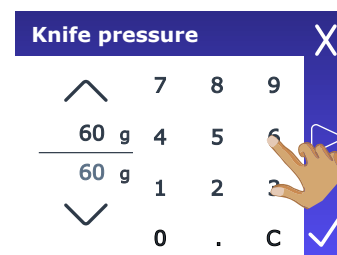
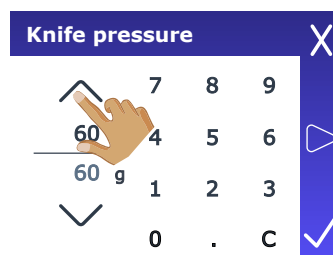
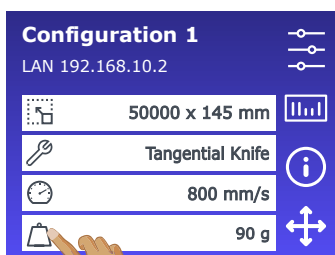

WARNING: Each keystroke can initiate an internal test or movement of the head or media. Keep fingers and other body parts away from the cutting area. There are hazardous moving parts present.

1. Power on the cutter and load the media (see section 1.5).



2. Tap .

3. Use the arrows to change the value...
4. or use the numbers to enter the new value.

1. Tap  to perform the internal knife pressure test.
2. Tap  to confirm the chosen knife pressure.
3. Tap  to leave the pressure unchanged.

Once  is pressed, the current knife pressure is automatically set to the new value and the cutter will cut the knife pressure test pattern.

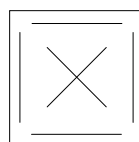

FIG 1-23
KNIFE PRESSURE TEST PATTERN

Peel out the rectangle and inspect the media backing.

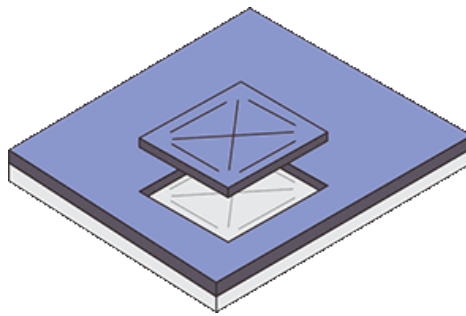

FIG 1-24
PEELED KNIFE PRESSURE TEST PATTERN

The knife depth is set correctly when the test pattern is cut completely through the vinyl, the vinyl is removed, and the blade tip visibly scratched the front side of the media backing. The blade should never cut through the backing; only slightly scratch its silicon coating and first few fibres.

Because the knife pressure setting depends on the thickness and type of media to be cut, adjusting the knife pressure will require some practice. In general, the knife depth must be increased when using thicker types of vinyl and decreased when using thinner types of vinyl.



ATTENTION: After setting the cutting depth and/or the knife pressure, perform a thorough visual check of the knife blade protruding from the knife holder and test the cutting results on a scrap of vinyl media.



CAUTION: Do not operate the cutter if the knife blade cuts through the media backing, as this will seriously damage the cutter's rubber cutting strip and the knife.



CAUTION: For most vinyl cutting operations, the knife blade tip will be barely visible at the bottom of the knife tool. If the knife blade tip is clearly visible, the cutting depth must be readjusted. To prevent damage to the cutter, check the depth of the knife blade tip and the quality of the cut each time you load a different type of vinyl into the cutter.

1.6.1.2 Pen installation

The S Class 3 cutters can also function as a pen plotter when a pen is installed.

1. Loosen the head clamp screw and remove the tool from the clamp.
2. Install the pen in the clamp and tighten the clamp screw.
3. You can change the tool on the touch panel, in Summa Cutter Control (PC only) or in the cutting software.

Changing to the pen tool disables the knife offset correction and changes the pressure to pen pressure.



ATTENTION: The information on the touchscreen shows the currently selected tool by the cutter. Make sure the cutter's tool setting matches the actual tool in use.



FIG 1-25
KNIFE IS CHOSEN TOOL



FIG 1-26
PEN IS CHOSEN TOOL

1.6.2 Cutters with tangential head

1.6.2.1 Tangential knife installation

A knife is pre-installed in your cutter. For safety reasons, the knife depth has been set to zero. Turn out the knife before cutting. The complete description of how to remove or install a knife can be found below.



ATTENTION: To fully benefit from the advantages of the tangential knife, the degree to which the knife extends is very important. The knife depth should not be controlled by the knife pressure, but by the nose piece whose two rollers touch the material.

➤ *Removing the tangential knife*

1. Turn the knife holder counterclockwise. The knife holder rises and can eventually be lifted out of the tangential head. The nosepiece is situated underneath. Remove this part if another tool is going to be installed in the cutter.

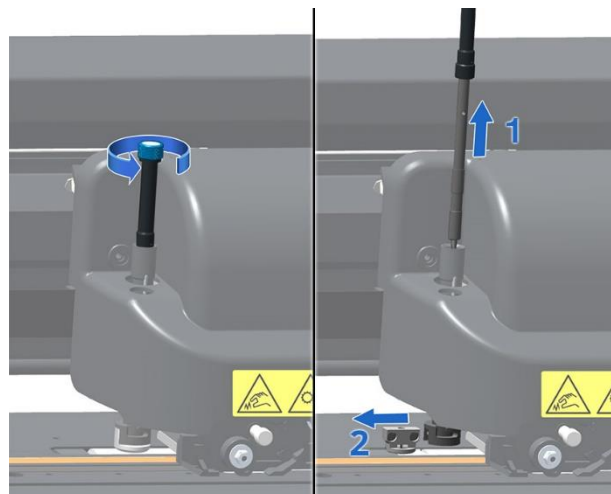

FIG 1-27
REMOVING THE TANGENTIAL KNIFE HOLDER

2. The knife can be removed from the knife holder by using something like a flat screwdriver to gently pry in the groove between the knife and the knife holder.

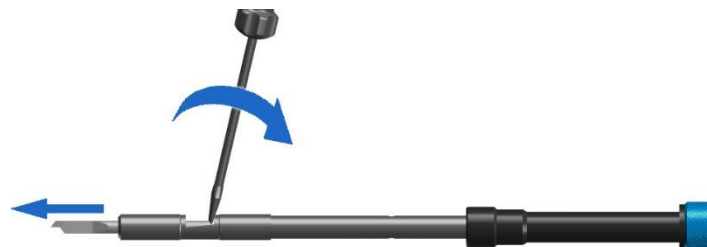

FIG 1-28
REMOVING THE KNIFE FROM THE TANGENTIAL KNIFE HOLDER

➤ *Installing the tangential knife and setting the knife depth*

3. Insert the standard knife blade into the knife holder. Make sure the knife blade is firmly fixed in the holder. The knife is inserted correctly if it cannot be manually removed from the knife holder. The installation tool can be used to apply enough pressure on the knife in order to secure it.



FIG 1-29
BLADE ASSEMBLY

4. Insert the nosepiece from the side until it snaps into place. Gently insert the knife into the tool shaft. Hold the nosepiece in place with one hand and, with the other hand, turn the knife holder counterclockwise until the alignment pin fits into the small notch of the tool shaft. Now turn the knife holder clockwise until its thread fits inside the tool shaft.

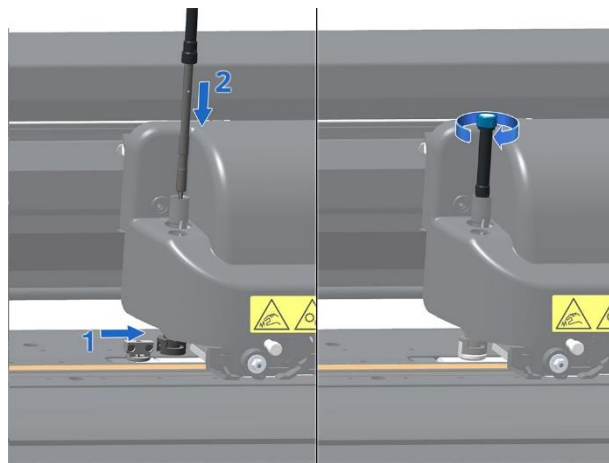

FIG 1-30
INSERTING THE TANGENTIAL KNIFE HOLDER

5. Hold the nosepiece in place with one hand. Adjust the knife depth with the other hand by turning the knife holder clockwise until the knife tip is just visible from underneath the nosepiece.

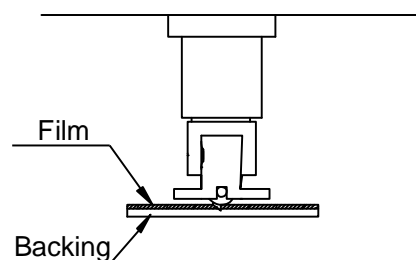

FIG 1-31
KNIFE DEPTH ADJUSTMENT

- **Setting the pressure and checking the knife depth**
(the media must be loaded in the cutter before the knife pressure can be tested)



WARNING: Each keystroke can initiate an internal test or movement of the head or media. Keep fingers and other body parts away from the cutting area. There are hazardous moving parts present.

1. Power on the cutter and load the media (see section 1.5).





2. Tap .

3. Use the arrows to change the value... 4. or use the numbers to enter the new value.

1. Tap  to perform the internal knife pressure test.

2. Tap  to confirm the chosen knife pressure.

3. Tap  to leave the pressure unchanged.

Once  is pressed, the current knife pressure is automatically set to the new value and the cutter will cut the knife pressure test pattern.

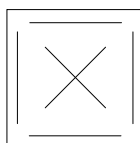

FIG 1-32
KNIFE PRESSURE TEST PATTERN

Peel out the rectangle and inspect the media backing.

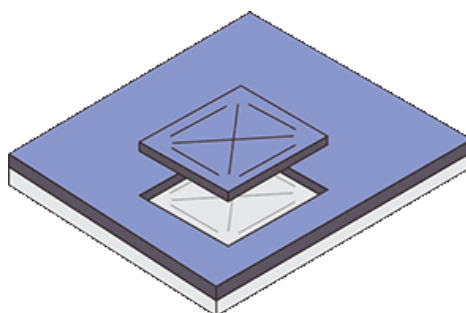

FIG 1-33
PEELED KNIFE PRESSURE TEST PATTERN

The knife depth is set correctly when the test pattern is cut completely through the vinyl, the vinyl is removed, and the blade tip visibly scratched the front side of the media backing. The blade should never cut through the backing; only slightly scratch its silicon coating and first few fibres.

Because the knife pressure setting depends on the thickness and type of media to be cut, adjusting the knife pressure will require some practice. In general, the knife depth must be increased when using thicker types of vinyl and decreased when using thinner types of vinyl.



NOTE: The knife pressure can also be used to check the knife depth (which is controlled by the extent to which the knife is turned out of the nosepiece). If the correct knife pressure is raised by 150 gr, then the knife should not cut through the backing of the vinyl. If it does cut through the backing, the knife depth needs to be reduced.



ATTENTION: After setting the cutting depth and/or the knife pressure, perform a thorough visual check of the knife blade, protruding from the knife holder and test the cutting results on a scrap of vinyl media.



CAUTION: Do not operate the cutter if the knife blade cuts through the media backing, as this will seriously damage the cutter's rubber cutting strip and the knife.



CAUTION: For most vinyl cutting operations, the knife blade tip will be barely visible at the bottom of the knife tool. If the knife blade tip is visible, the cutting depth must be readjusted. To prevent damage to the cutter, check the depth of the knife blade tip and the quality of the cut each time you load a different type of vinyl into the cutter.

1.6.2.2 Pen installation

The S Class 3 cutters can also function as a pen plotter when a pen is installed.

1. Turn the installed tool counterclockwise. The holder rises and can eventually be lifted out of the tangential head. The nosepiece is situated underneath. Remove this part if it is mounted.
2. Gently insert the ballpoint pen holder into the tool shaft.
3. Turn the ballpoint pen clockwise all the way down.
4. The change of tool can either be done on the touch screen with Summa Cutter Control or with the cutting software. Selecting the pen operation changes the pressure to pen pressure.



ATTENTION: The information on the touch panel shows the tool, currently selected by the cutter. Make sure the cutter's tool setting matches the actual tool in use.

1.6.3 Cutters with performance head

The installation of the tangential knife, drag knife, and pen as tools in the rear tool shaft is the same as described in section 1.6.2.

The second tool (creasing tool or extra pen) can be installed in the front tool shaft. The procedure for installation and setup is described in the following sections.

1.6.3.1 Creasing tool installation

Remove the black plug from the front tool shaft if necessary.

Gently insert the creasing tool into the front tool shaft. Turn the creasing tool clockwise, all the way down. The process of installing the extra pen is the same.

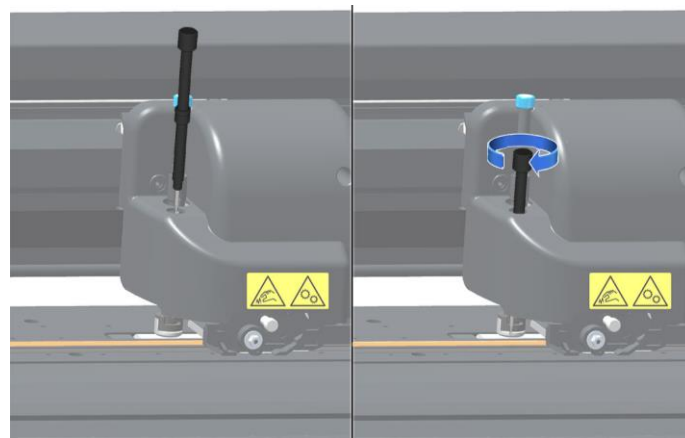

FIG 1-34

1-34 INSERTING THE CREASING TOOL

1.6.3.2 Setting up the second tool

When an S Class 3 TC model cutter is powered on and media is loaded, a small number is displayed next to the tool icon. This number corresponds to the tool shaft.

When the number '1' is displayed, the display shows the currently installed tool in the rear tool shaft, along with its pressure. When the number '2' is displayed, the display shows the currently installed tool in the front tool shaft, along with its pressure.

The figure below displays a screenshot of the touch screen of an S Class 3 TC model. In the rear shaft, a tangential knife is loaded, set to cut at a speed of 800 mm/s with a pressure of 90 grams.

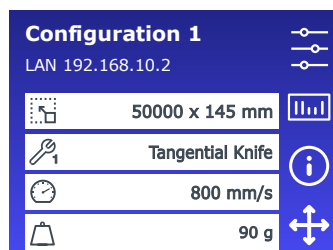
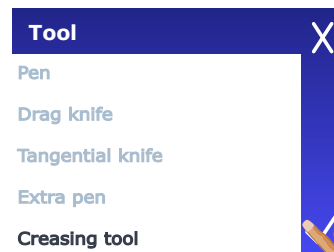
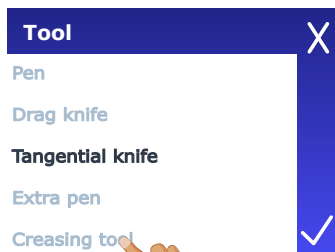
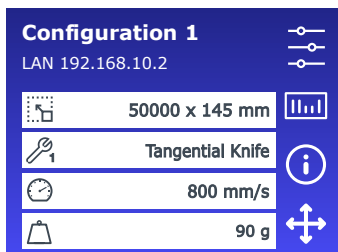

FIG 1-35

1-35 TOUCH SCREEN ON A TC MODEL

To set up a second tool in the front shaft do following:

1. Power on the cutter and load the media. The display will show the tool (along with its corresponding tool shaft) that was last displayed before the cutter was powered off. The cutter will not identify the tool in the other tool shaft. The pressure displayed on screen will be the stored pressure for that tool. The cutter stores only one speed for both tools, and that speed will be the one displayed.



2. Tap 1.

3. Select the **Creasing tool**.

4. Tap to confirm.

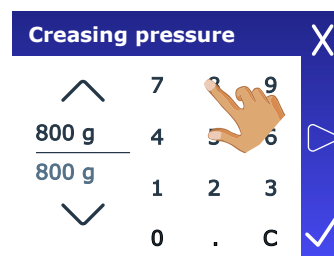
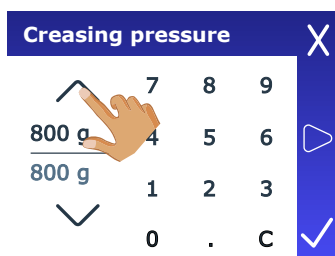
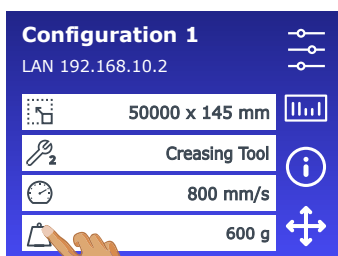

5. Tap .

6. Use the arrows to change the value...
7. or use the numbers to enter the new value.

4. Tap to perform the internal creasing pressure test.

5. Tap to confirm the chosen creasing pressure.

6. Tap to leave the pressure unchanged.

Once is pressed, the current creasing pressure is automatically set to the new value and the cutter will cut the creasing pressure test pattern.



NOTE: The speed for both tool 1 and tool 2 is the same. If there is a significant difference in speed used during the job between the two tools, it is advisable to temporarily adjust the speed for the pressure test. The actual job's speed will be controlled by the software sending the job data.



NOTE: The head is not equipped with sensors to recognize mounted tools. Therefore, when the machine is powered off and on again, the display will show the same tool as before the machine was powered off. The cutter won't recognize the tool in the other tool shaft and may request insertion if needed.

1.6.4 Replacement of the separation knife blade

If the separation knife (razor blade) is installed, you can automatically cut off the job after it is finished.



ATTENTION: This separation knife should only be used with standard vinyl (max. 0.25 mm thick).

1. Remove the razor blade holder by turning the knurled screw at the bottom of the tool carriage.
2. The razor blade is kept in its place by a small magnet. Turn it around or replace it when it is worn down; figure 1-b.

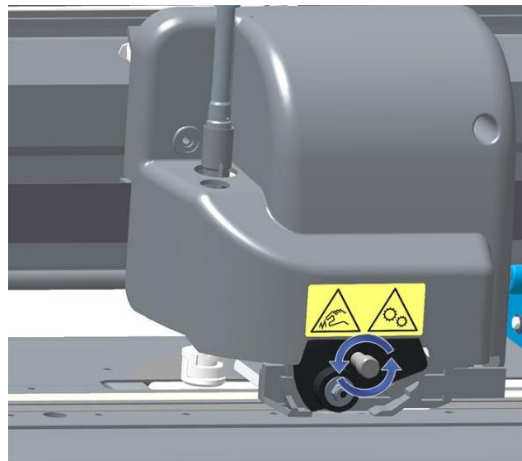

1-36

RAZOR BLADE FOR AUTOMATIC SEPARATION OF MEDIA



ATTENTION: The assembly is tilted under an angle of +/- 30° when it is remounted on the machine. Mind the position of the assembly before replacing the razor blade.

1.7 Activation of Wi-Fi (if available in your region) and the barcode feature

The barcode function and Wi-Fi option are both options that need to be activated by registration before they can be used. Registration is done via our website (www.summa.com/support/product-registration) using the cutter's serial number, found on the label at the back of the cutter and in the system setup menu. We recommend retrieving the serial number directly from the system setup menu.

Step one: obtaining the serial number

1. Power on the cutter.

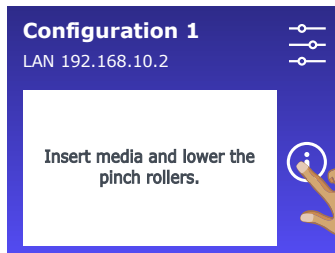

2. Tap



3. Write down the serial number.

Step two: activation of Wi-Fi (if available in your region) and/or the barcode feature

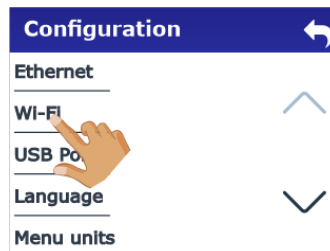
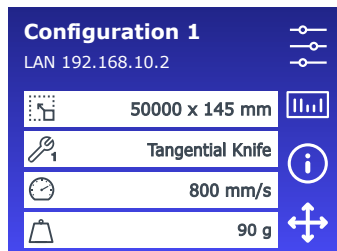

1. Go to the webpage and register your cutter. The webpage will show a 6-digit activation code which will also be sent to you via email, along with the cutter's serial number. Save this email for future reference.
2. Power on the machine and load the media (see section 1.5).

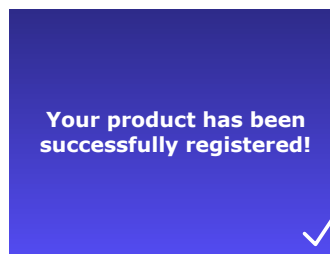
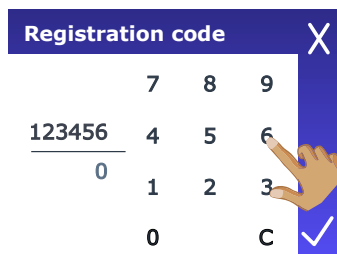

3. Tap  for the barcode feature...

... or navigate to **Configuration > Wi-Fi** for Wi-Fi.



4. Enter the code and tap .
5. Tap .

2.1 Touchscreen

2.1.1 Introduction

The touchscreen is a unique interface system providing detailed information on the cutter status and offers a flexible and powerful configuration control. In addition to the status messages and/or menu options displayed on the touchscreen, icons can be tapped to change menu items or the value for a particular submenu/parameter.

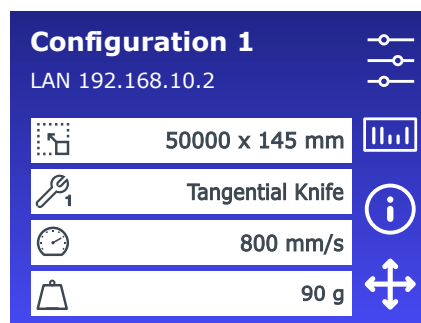

FIG 2-1
TOUCHSCREEN

There is also a screen saving feature. After a certain amount of time, the screen goes blank and the Summa logo appears. If applicable, tips or advice will be shown instead of the Summa logo (e.g. when the pinch rollers are down while the cutter is not cutting).



FIG 2-2
POSSIBLE SCREEN SAVER DISPLAY

Tapping the screen once disables the screen saver.



WARNING: Each keystroke can initiate an internal test or movement of the cutting head or media. Keep fingers and other body parts away from the cutting area. There are hazardous moving parts.

2.1.2 Basic operation

2.1.2.1 Control buttons



: Gives access to the main menu. Tapping this button will cause the cutter to go offline and suspend all operations in progress. The main menu contains all parameter settings, submenus and access to tests and calibration routines. The chosen tool influences the displayed settings.



: Displays the current origin and arrow keys to change it.



: Starts the barcode workflow, explained in section 3.3.3.



: Displays information about the firmware version and serial number.



: Appears when the cutter is cutting a job. Tap it to stop the current job.



: Appears when the cutter is cutting a job. Tap it to pause the current job.

2.1.2.2 Current settings

	50000 x 145 mm
	Tangential Knife
	800 mm/s
	90 g

The default screen shows an overview of the most important settings such as media size, current tool, current tool speed and current tool pressure. By tapping the displayed value, you can quickly change it. These parameters can also be changed in the different menus (see section 4).

2.2 Ease of use

All the blue parts (pinch roller blocks, pinch roller lever, knife adjustment screw) can be moved or adjusted.

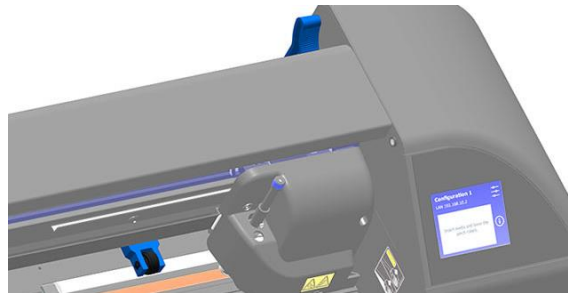

FIG 2-3
2-3 BLUE PARTS

The S Class 3 3 has status light bar integrated in the top cover:



FIG 2-4
2-4 BLUE STATUS LIGHT

The cutter is in idle mode, waiting for user input or ready to start a job (in case the start screen is displayed).

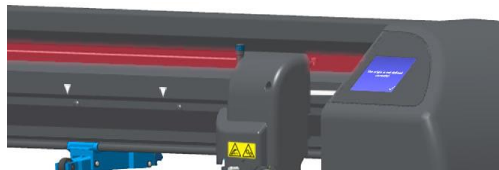

FIG 2-5
2-5 Red status light

An error has occurred, and intervention is required.

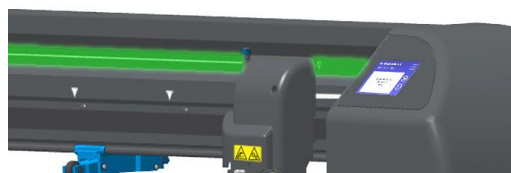

FIG 2-6
2-6 GREEN STATUS LIGHT

The cutter is currently actively performing a task or operation (loading, cutting,...).

2.3 How to Set Tool Parameters

The S Class 3 cutters can operate with a knife, pen, or creasing tool installed. Once a tool has been changed, the tool parameters must be reset or checked. All tools have one parameter in common: pressure. Each tool also has its own specific parameters. You can change tool parameters in the current user or by changing the user itself (see section 2.5).



ATTENTION: The S Class 3 cutters will only perform according to the specifications if a genuine Summa tool is installed. Do not replace with tools from other manufacturers.



WARNING: Each keystroke can initiate an internal test or movement of the head or media. Keep fingers and other body parts away from the cutting area. There are hazardous moving parts present.

2.3.1 Setting the tool type

1. Power on the cutter and load the media (see section 1.5).

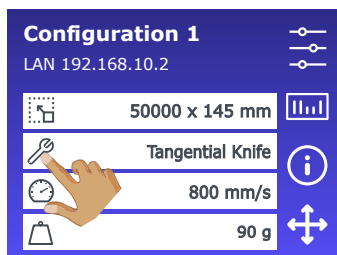

2. Tap .



3. Tap a tool name to select it.

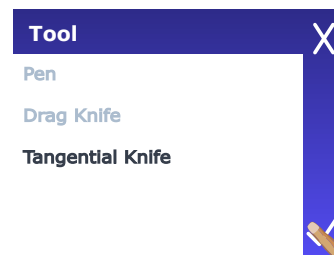

4. Tap  to confirm.

After the tool type is changed on-screen, the cutter will prompt the user to install the new tool.



NOTE: If no media is loaded, you can access the tool menu by tapping . After the media is loaded, the cutter will prompt the user for a tool change if necessary (see section 4.2.4).

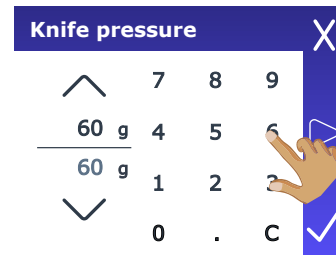
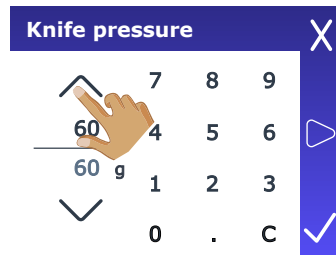
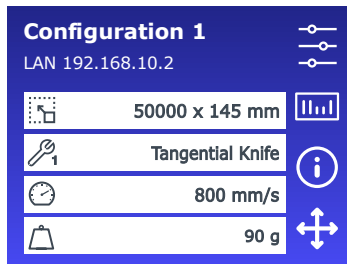

2.3.2 Changing tool pressure

1. Power on the cutter and load the media (see section 1.5).



2. Tap .

3. Use the arrow keys to change the value...
4. ...or use the numbers to enter the new value.

1. Tap  to perform the internal knife pressure test.
2. Tap  to confirm the chosen knife pressure.
3. Tap  to leave the pressure unchanged.

Once  is tapped, the current knife pressure value is automatically set to the new value and the cutter will cut the knife pressure test pattern.

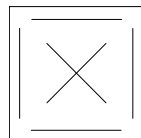

FIG 2-7
KNIFE PRESSURE
TEST PATTERN

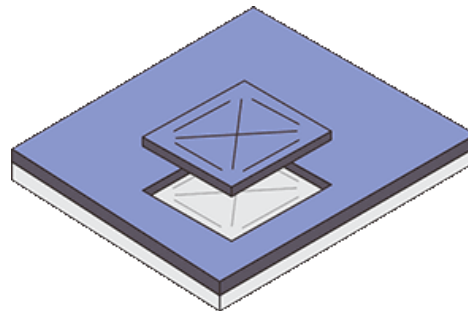

FIG 2-8
PEELED TEST PATTERN

The knife depth is set correctly when the test pattern is cut completely through the vinyl, the vinyl is removed, and the blade tip visibly scratched the front side of the media backing. The blade should never cut through the backing; only slightly scratch its silicon coating and first few fibres.

2.3.3 Changing the drag knife offset

The offset is a very important parameter for a drag knife. The offset is the distance between the knife centre and the knife tip.



NOTE: The knife offset should be set each time the knife is changed and should be checked when the knife shows signs of wear.



NOTE: A typical knife offset for Summa knives is between 0.41 and 0.45 for standard knives, between 0.90 and 0.97 for sandblast knives and between 0.49 and 0.52 for the 60° knife.



NOTE: Sandblast knives should be used when the material that needs to be cut is thicker than 0.25 mm.

Changing knife offset:

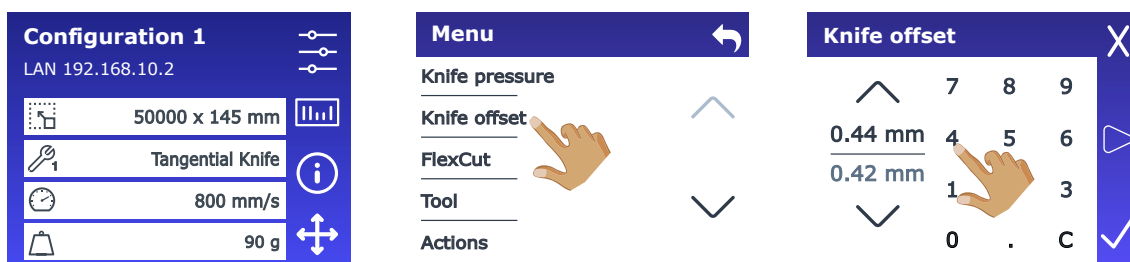

1. Power on the cutter and load the media (see section 1.5).



2. Tap .

3. Tap **Knife offset**.

4. Use the arrow keys or the numbers to change the value.

1. Tap  to perform the internal knife offset test.
2. Tap  to confirm the chosen knife offset.
3. Tap  to leave the knife offset unchanged.

Once  is tapped, the current knife offset value is automatically set to the new value and the cutter will cut the test pattern.



Adjust the knife offset until the cut pattern is correct.

2.3.4 Calibrating a tangential knife

The purpose of the knife calibration routine is to detect and, if necessary, correct problems related to the concentricity of the tangential knife blade.



NOTE: The knife must be calibrated every time it is replaced, and the calibration must be checked again when the blade shows signs of wear.

During knife calibration, the cutter cuts a series of test patterns for the user to allow identifying errors in the knife rotation and concentricity.

2.3.4.1 Calibrating

1. Power on the cutter, load the media (see section 1.5) and install the tangential knife (see section 1.6.2.1.).

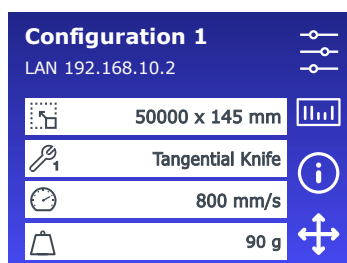

2. Tap .

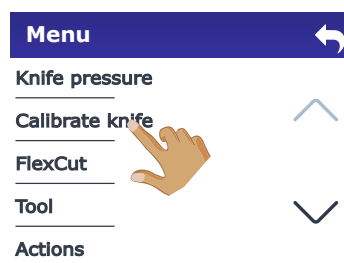

3. Tap **Calibrate knife**.





4. Tap the parameter that needs to be changed. First set the origin, then the other parameters.



5. Use the arrow keys or the numbers to change the value.



NOTE: Failing to set the knife parameters correctly will result in poor cut quality.

1. Tap  to perform the tangential knife calibration test, each time a parameter was changed.
2. Tap  to confirm the chosen value.
3. Tap  to leave the value unchanged.

Once  is tapped, the current value is automatically set to the new value and the cutter will cut the test pattern.

Analyse the test pattern that is cut. It should look like this:

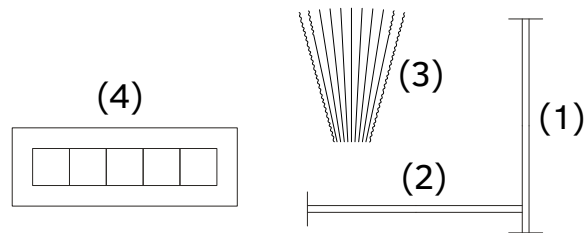

FIG 2-10
CORRECT TANGENTIAL KNIFE CALIBRATION TEST

Rectangle (1) and (2) should weed out (remove) smoothly without sticking to the rest of the vinyl. The fan-shaped pattern (3) should have a clear, straight cut line in the middle while the other cut lines are irregular. The squares (4) should be aligned and equal in size.



NOTE: Not all test pattern results may be perfect (this depends on the type of vinyl). Test patterns 1 and 4 are the most important test patterns and they must be as perfect as possible.

If the results are not correct, make corrections as described in section 2.3.4.2.

2.3.4.2 Making corrections

Knife calibration errors may be caused by:

- **Origin deviation** (1) The knife tip is slightly rotated in relation to its theoretical 0° angle. This error can be corrected by adjusting the origin.
- **Lateral deviation** (2) The knife tip deviates from its theoretical centre in lateral direction. This error can be corrected by adjusting the lateral parameter.
- **Longitudinal deviation** (3) The knife tip deviates from its theoretical centre in longitudinal direction. This error can be corrected by adjusting the longitudinal parameter.

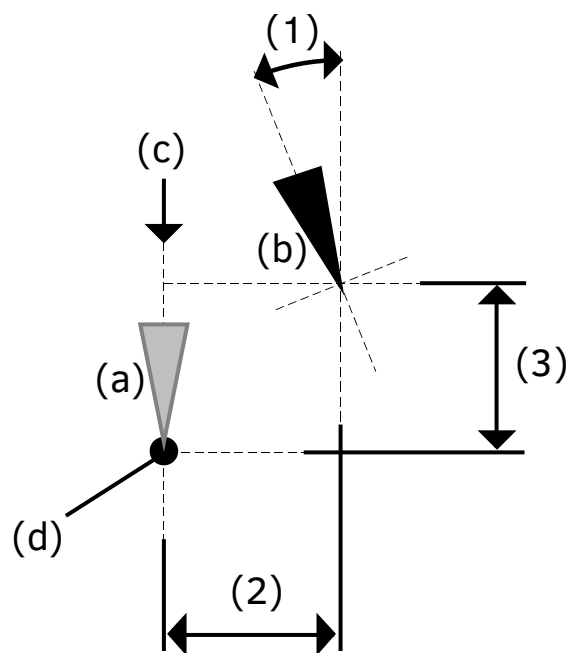

FIG 2-11
POSSIBLE KNIFE CALIBRATIONS

- (a) Theoretical knife position
- (b) Actual knife position
- (c) Theoretical knife direction
- (d) Theoretical knife centre

Origin correction

If the clear cut line in test pattern 3 is located too much to the right, increase the value of the origin. It sometimes helps to gently feel the pattern to find out which side has the clear cut line. If the clear cut line in test pattern 3 is located too much to the left, decrease the value of the origin.

Lateral correction

Weed out (remove) the rectangle in pattern 1 and in pattern 4. If the test pattern resembles the pattern below, decrease the value of the lateral parameter to correct the closing cut lines.

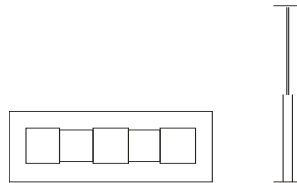

If the test pattern resembles the pattern below, increase the value of the lateral parameter to correct the closing cut lines.

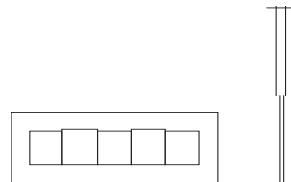
*Longitudinal correction*

Weed (remove) out the rectangle. If the test pattern resembles the pattern below, decrease the value of the longitudinal parameter to correct the closing cut lines.



If the test pattern resembles the pattern below, increase the value of the longitudinal parameter to correct the closing cut lines.



2.4 How to Set the Cutting Speed

The actual speed at which the tool moves is determined by 4 different parameters: speed (1) and acceleration (2) while the tool is down, and speed (3) and acceleration (4) while the tool is up. These parameters can be set individually via Summa Cutter Control, but we recommend working with the **Velocity** parameter to make changing the cutting speed as easy and efficient as possible. You choose the **Velocity** (the speed at which the tool moves when it is down), and the other parameters are automatically changed as necessary to create an optimal combination of speed and acceleration for your chosen value.

There is one fixed speed: the speed at which the cutter pulls the media from the roll. This speed is fixed at 200 mm/s (8ips).

Setting the cutting speed:

1. Power on the cutter and load the media (see section 1.5).



2. Tap .

3. Tap the new velocity to select it (scroll with the arrows, if necessary).

4. Tap  to confirm.



NOTE: The speed can also be set in the  menu, see section 4.4.1 for more information on this menu.

2.5 How to Change the User (Quick Parameter Change)

The S Class 3 cutters include 8 user configurations, all set up with the same parameters. However, the settings of these parameters may differ for each configuration. This allows the cutter to be quickly and easily reconfigured for different types of jobs or media.



NOTE: Factory default values for the different users are all set the same.

Changing the User Configuration:

1. Power on the cutter and load the media (see section 1.5).

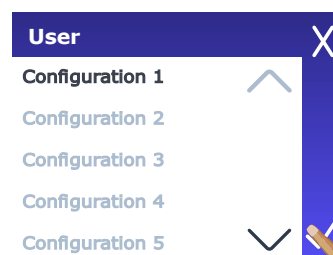
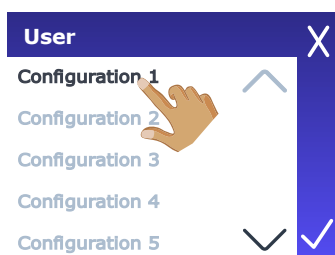
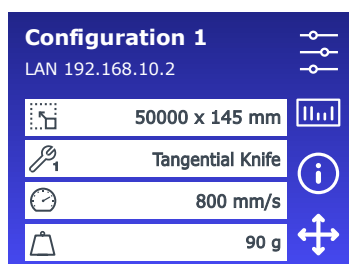

2. Tap the current user.
3. Tap the new user to select it.
4. Tap  to confirm.



NOTE: The name of the configuration can be changed in Summa Cutter Control.

2.6 How to Make Sure the Sign Has the Correct Size (Length Calibration)

The S Class 3 cutters are friction-feed machines, so the cutting length depends on the thickness of the material.

The cutters have been calibrated in the factory for standard 2-mil cast or 3-mil calendared vinyl. Each user (the S Class 3 has a total of 8) can hold a different calibration factor. This is very helpful for multi-coloured signs: it ensures that the parts in different colours match up, even if different types of vinyl media are used.



ATTENTION: For standard use, it is not necessary to calibrate the machine. With standard vinyl, the accuracy is within 0.2%. However, if high accuracy is required, calibration is necessary.

Calibrating the media (Length calibration):

1. Power on the cutter.
2. If the menu units are already being displayed metrically, continue with step 6. If the menu units are not displayed metrically, perform steps 3 to 5.

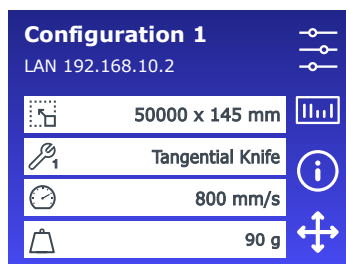

3. Tap .

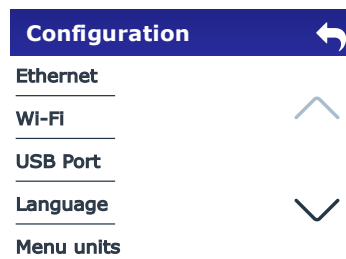

4. Scroll down with the arrow and tap **Menu units**.

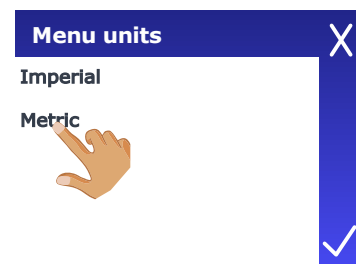

5. Tap **Metric**.

6. Load the media (see section 1.5).

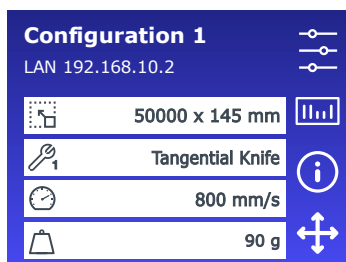

7. Tap .

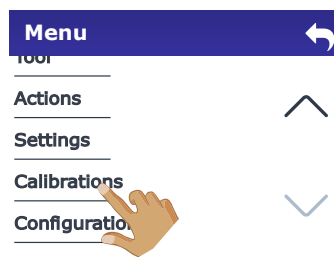

8. Scroll down with the arrow and tap **Calibrations**.



9. Tap **Length calibration**.

The cutter will reload the media and perform the length calibration test. Take out the media and measure the length of the cut line using a ruler (measuring device). Enter the distance between line 1 and line 2 as shown in the figure below.



FIG 2-12
LENGTH CALIBRATION PATTERN



NOTE: The cutter will only be as accurate as the accuracy of the calibration. If the ruler used in calibration is inaccurate, recalibrating may worsen the accuracy of the cutter. The accuracy of the calibration will be reflected directly in the cuts.



10. Tap to enter the value or to leave the menu without changing.

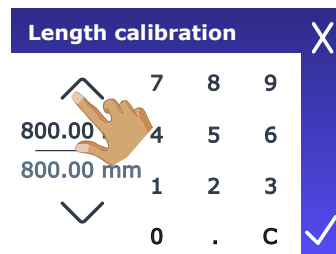

11. Use the arrow keys to change the value...

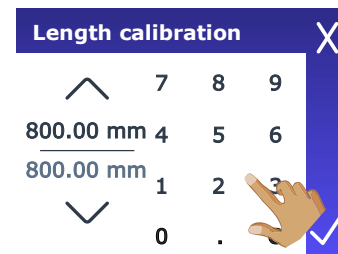

12. ...or use the numbers to enter the new value.

13. Tap to confirm the value of the measured distance.



NOTE: Consider changing the username once the user is calibrated. It will make future reference easier.

2.7 FlexCut for cutting through

2.7.1 Procedure

The FlexCut (cutting through) functionality focusses on cutting simple shapes (e.g. rectangles). It is mostly used in combination with contour cutting. An interrupted cutting line makes sure that the material remains together thanks to the small media bridges. When the job is finished the cut pieces can be torn loose.

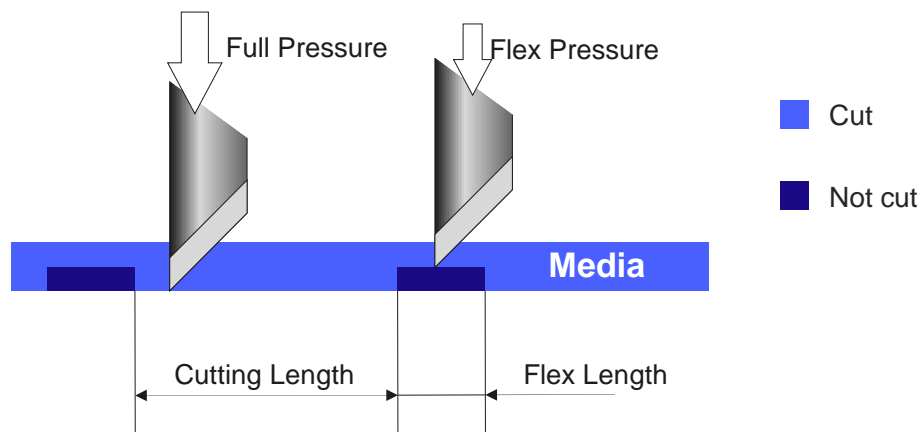

FIG 2-13
FLEXCUT PRINCIPLE

Some cutting software programs can recognize the difference between a contour line and a cut-through line. The software first sends the contour line data to the cutter, then activates FlexCut, panning mode and vector sorting, and ultimately sends the cut-through data to the cutter. If your cutting software cannot do this, you will need to send the contour line data separately, set the cutter in FlexCut mode manually and then send the cut-through data.

Setting the parameters for cutting through the media:



NOTE: The following procedure describes how to set the parameters for FlexCut. The parameters used in the example below are 180 g and 10 mm for full pressure, 80 g and 1 mm for FlexCut pressure, and auto speed. Section 2.7.2.3 describes how to get the exact parameters for the media that you will be using.

1. Power on the cutter and load the media (see section 1.5).

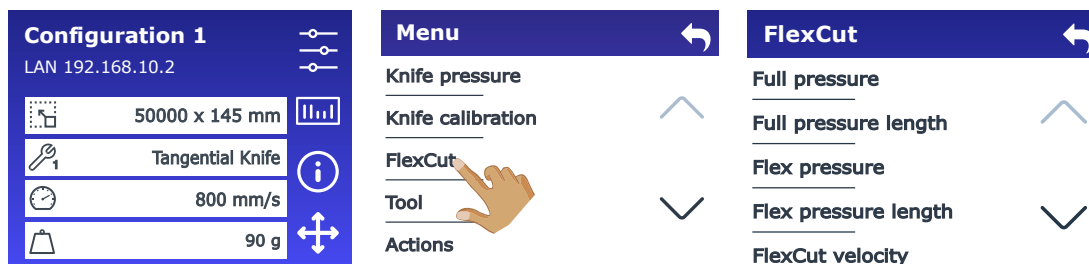

2. Tap .
3. Tap **FlexCut**.
4. Tap the parameter that needs to be changed.



Use the arrow keys or the numbers to change the value.



Use the arrow keys or the numbers to change the value.



Use the arrow keys or the numbers to change the value.



Use the arrow keys or the numbers to change the value.

- Set the parameters (check section 2.7.2.3). Tap  to cut the internal FlexCut test pattern.
- Check the bridges. If they are too large, perform a test with a lower value. If they are too small (or non-existent), raise this value. Reducing the velocity can also improve the result. We do not recommend using cutting speeds larger than 400 mm/s (16 ips) with cutting pressures exceeding 200 g.



ATTENTION: It is difficult to give the recommended settings for FlexCut. Check section 2.7.2.3.



NOTE: FlexCut parameters are always metric, regardless of the value chosen under **Configuration > Menu units**.



ATTENTION: When cutting through, it is recommended that parallel lines are at least 1 cm (0.4") apart. Otherwise, while cutting the second line, the first line may come loose and cause trouble.

7. After having set the parameters scroll to the bottom of the FlexCut parameters to set panel size.



8. Tap **FlexCut panel size**.

9. Use the arrow keys or the numbers to change the value.

10. Tap  to confirm.



NOTE: The above procedure must be performed, even if your software can activate FlexCut. It is also recommended to set the FlexCut parameters on the cutter and not in the cutting software.



NOTE: Recommended settings for **FlexCut panel size**: 3-10 cm.

2.7.2 Practical tips

2.7.2.1 Physical knife depth tangential knife

Although very similar, there are two types of knife depth settings: one for normal cutting and one for when FlexCut is used. What they have in common is that the knife is never turned out far.

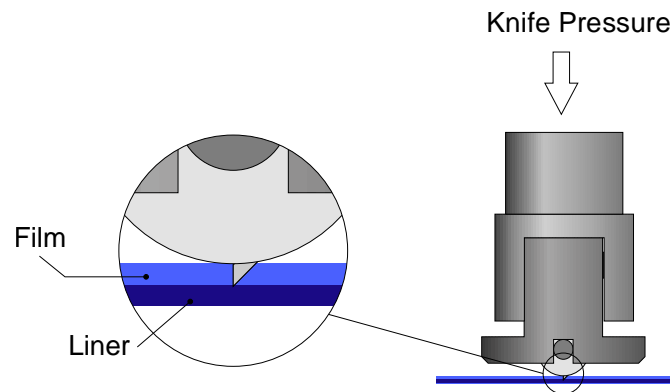

FIG 2-14
KNIFE DEPTH SETTING NORMAL CUTTING

During normal cutting, the knife is turned out just a little further than the actual cutting depth, so that the knife tip only scratches the backing. Turning out the knife further would result in unstable knife pressure and bad cutting quality.

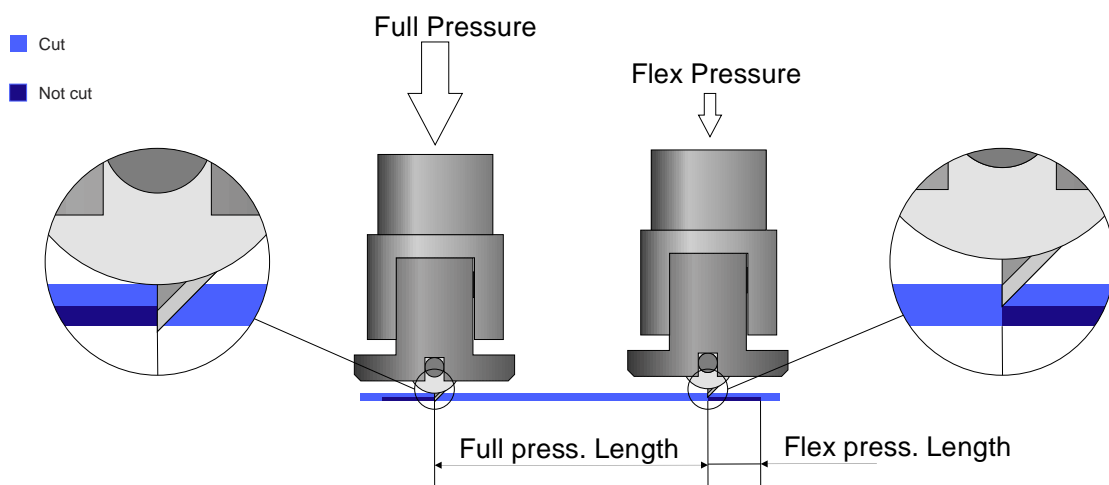

FIG 2-15
KNIFE DEPTH SETTING CUTTING THROUGH

When performing FlexCut, the knife is turned out just far enough to cut through the vinyl and its backing. It is recommended to let the nose piece touch the media at full pressure.

2.7.2.2 Physical knife depth drag knife

Although very similar, there are two types of knife depth settings: one for normal cutting and one for when FlexCut is used. What they have in common is that the knife is never turned out far.

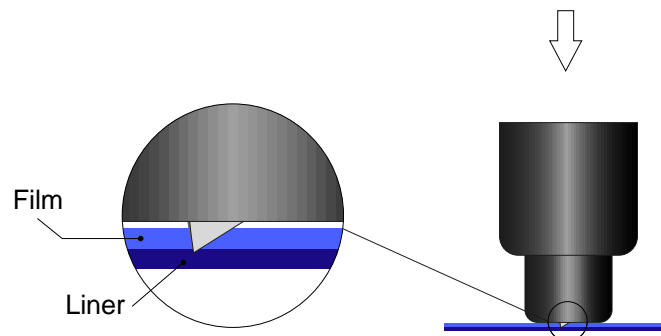

FIG 2-16
KNIFE DEPTH SETTING NORMAL CUTTING

During normal cutting, the knife is turned out just a little further than the actual cutting depth, so that the knife tip only scratches the backing. Turning out the knife further would result in unstable knife pressure and bad cutting quality.

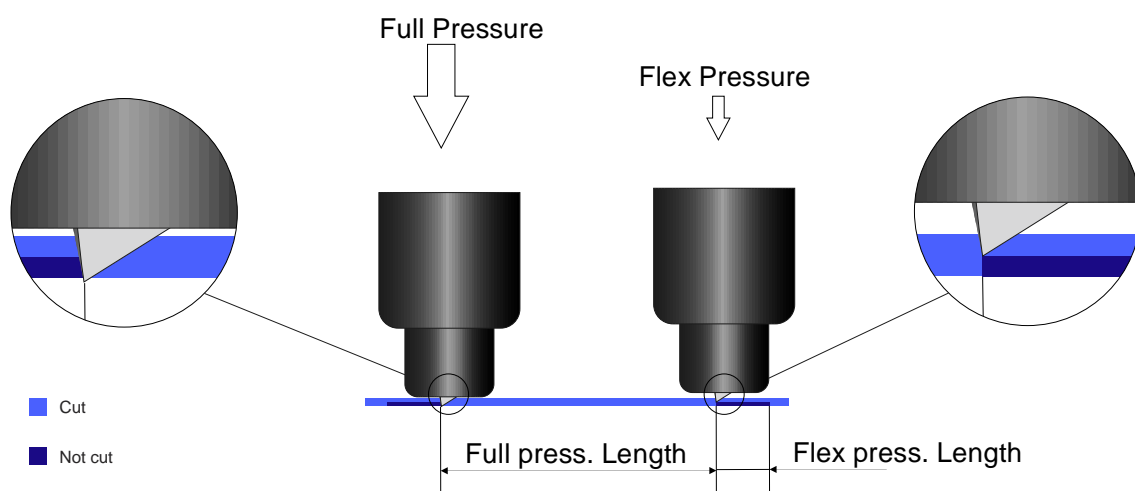

FIG 2-17
KNIFE DEPTH SETTING CUTTING THROUGH

When performing FlexCut, the knife is turned out just far enough to cut through the vinyl and its backing. Whether you can rest the knife holder on the media at full pressure depends on the actual media you are using. If it is prone to scratching, make sure the bottom of the knife holder does not touch the media at full pressure. If the media is not prone to scratching, we recommend letting the bottom of the knife holder touch the media at full pressure.

2.7.2.3 Values of the FlexCut parameters

Determining the values of the FlexCut parameters is done in two main steps. The first step is determining the 'fixed' pressure values. The second step is determining the length parameters empirically.

➤ **Step 1**

First go to the knife pressure test as described in section 2.3.2. Determine the pressure that is required to cut completely through both vinyl and backing. Make sure the pressure is not set too high and the knife is not turned out too far.

After the required pressure has been determined, turn the knife in a little more to check if it still cuts completely through. If this is the case, turn the knife in a little further. If it does not cut completely through, turn the knife out as it was. Now lower the knife pressure a little to check if it still cuts completely through. If this is the case, lower the knife pressure a little again. If this is not the case, set it at the previous value.



NOTE: Write down the pressure required to cut completely through and do not change the physical knife depth anymore (unless the knife has worn down a little).

Now, lower the knife pressure correctly to cut through just the vinyl. Write down this value.

➤ **Step 2**

Set the FlexCut parameters as described in section 2.7.1, using the following values:

- **Full pressure:** the value that was required to cut completely through the media (determined in step 1)
- **Flex pressure:** the value required to cut through the vinyl only.



NOTE: We do not recommend using cutting speeds higher than 400 mm/s (16 ips) with cutting pressures exceeding 170 g. So, if the full pressure is higher, lower the FlexCut velocity.

- **Full pressure length:** 10 mm.
- **Flex pressure length:** 1 mm.

Perform a test. Check the bridges. If they are too large, perform a test with a lower **Flex pressure length**. If they are too small (or none-existent), raise this value.

The FlexCut parameters are now set. If these settings need to be adjusted, try only changing the **Flex pressure length**. There is no need to adjust pressure settings unless the knife is wearing down. In that case, start again with step 1.



NOTE: It is not always easy to find the correct balance between cutting deep enough and making sure the pieces can be taken out easily, and not cutting too deep making sure the material keeps its strength while cutting. Sometimes this balance does not exist, and this material cannot be cut through with satisfactory results.

2.7.2.4 Material without backing

Although FlexCut was designed for use with standard vinyl (typical two-layered material), it can also be used with single-layered material. In this case the settings of the parameters are more difficult and require more trial-and-error tests than calibrating FlexCut for normal vinyl.

The only parameter that can be determined easily is **Full pressure**. The **Flex pressure** is very material-dependent. Plastics require a relatively high **Flex pressure**, whereas fibrous materials require a relatively low **Flex pressure**.

The **Flex pressure length** of plastic substrates is then relatively short, whereas fibrous substrates require longer bridges to keep the material together to be able to move it back and forth.

The principle, however, is the same. The parameters must be set so that the bridges are strong (long) enough to move the material back and forth without tearing, but small enough to be practically invisible once the object is removed from the material.

An additional help could be adjusting the panel size. For very weak material, reduce the panel size.

Overall, correct parameter setting for single-layered material takes a little longer.

3.1 Introduction

The S Class 3's highly accurate Optical Positioning System (OPOS) allows for contour cutting.

The OPOS sensor, which is mounted on the right-hand side of the tool carriage, registers squares (marks) printed around the graphic. Because of this registration process, OPOS can determine the exact position of the printed graphic.

The sensor automatically lowers to register the marks and rises after completing this task. The improved sensor can virtually read any kind of media-mark combination.

3.2 Basic OPOS operation

In general, contour cutting includes the following steps:

1. Create the graphic and contour cut line(s).



NOTE: Most RIP software requires that the contour lines are defined in a specific colour (spot colour). Please refer to the user manual that came with your software or contact your software dealer for specifics.

NOTE: Do not place contour lines along the edges of graphics, otherwise the slightest movement in the media may result in an unsatisfactory cut. Instead, practice one of the following techniques.



1. Place contour lines just inside the graphics.
 2. Place contour lines outside the graphics.
 3. Create thick borders around graphics and place contour lines inside these borders.
-

2. Print the graphic using a RIP that supports Print & Cut (lamine afterwards if necessary).
3. Load the graphic into the cutter.
4. Load the media and register the marks.
5. Cut the graphic.

Many versions of cutting software have the built-in capability to make contour cutting user-friendly and automatic. Please refer to the user manual that came with your software or contact your software dealer for specifics.

3.2.1 Printing the graphic

Print the graphic and its marks with a printer. Make sure there is a 2 cm (0.8 in) margin at the sides and the front, and at least a 4 cm (1.6 in) margin at the end of a roll or sheet. For shorter jobs the edge margins can be smaller, but they must be at least 1 cm (0.4 in).

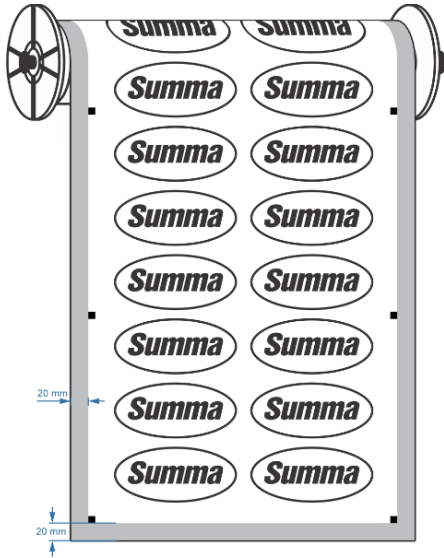

FIG 3-1
MARGINS PRINTING ON A ROLL

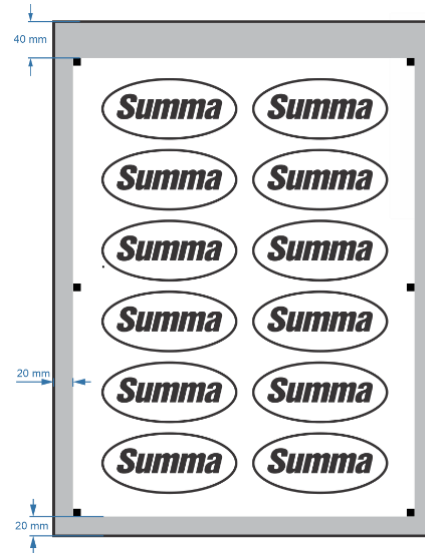
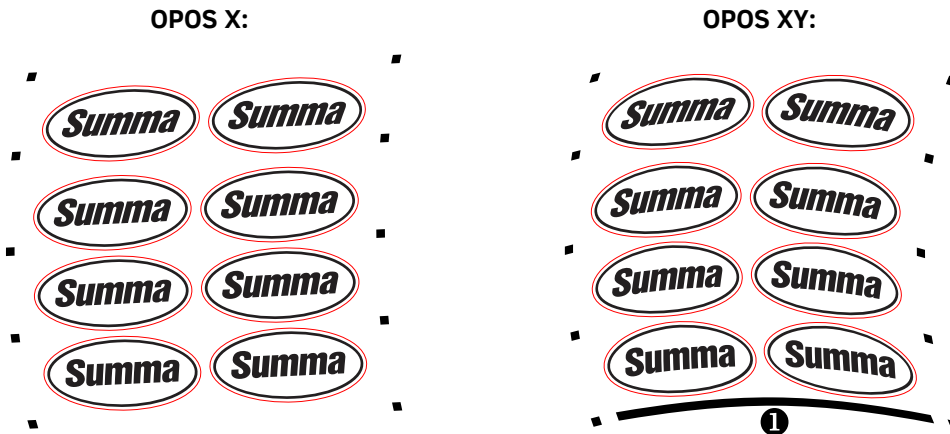

FIG 3-2
MARGINS PRINTING ON A SHEET

3.2.2 Different OPOS alignment methods

This parameter, although it is an internal parameter, needs to be set in the Print & Cut software. The following options are usually available:



A row of marks is printed at the left and right side of the graphic. These marks are read by the OPOS sensor and then used for compensating printing deformation.

An extra line at the bottom of the job is printed (line ① in the figure above), the sensor reads it and can also compensate for deformations along the width of the machine.

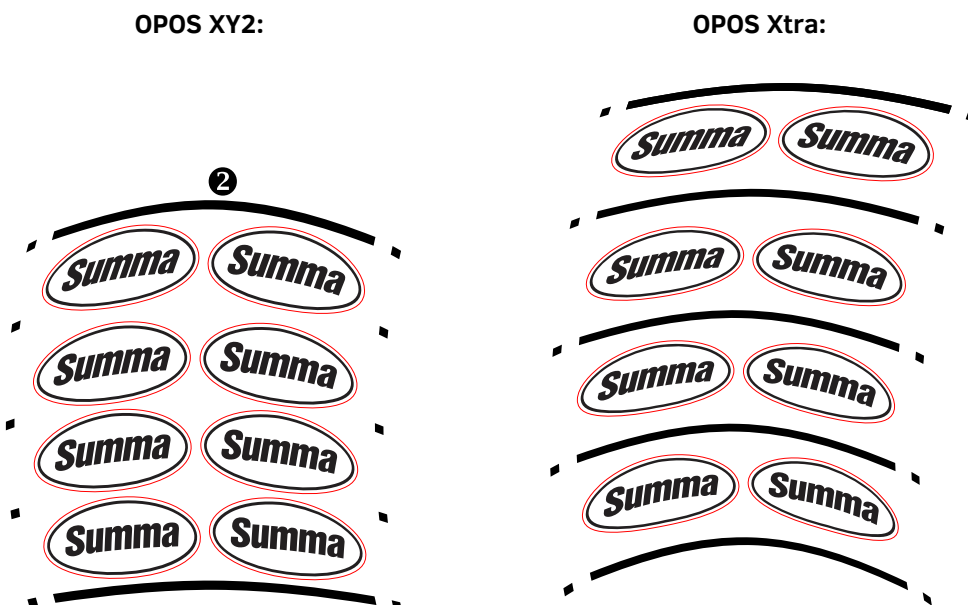

Analogue to the bottom XY line, a line (line ② in the figure above) is printed at the top of the job for cutting large jobs more accurately.

Analogue to the bottom XY line, a line is printed between each left-right mark.

FIG 3-3
OPOS ALIGNMENT METHODS

3.2.3 Processing long jobs

The OPOS sensor normally registers all the marks before cutting starts. However, in long jobs that can lead to extensive back-and-forth shifting of the media, which could lead to poor tracking. To avoid this, the parameter **Panelling** can be set in the cutter, dividing the job into panels.



NOTE: Activate the panelling function in the software OR in the cutter (not both).

Activating panelling:

1. Tap .

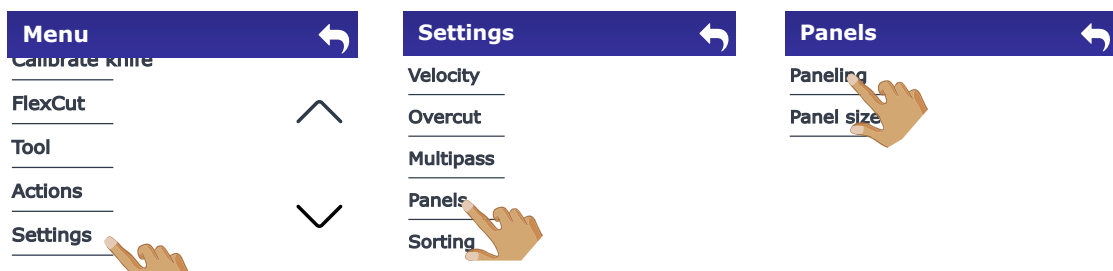

2. Scroll down with the arrow and tap **Settings**.

3. Tap **Panels**.

4. Tap **Panelling**.

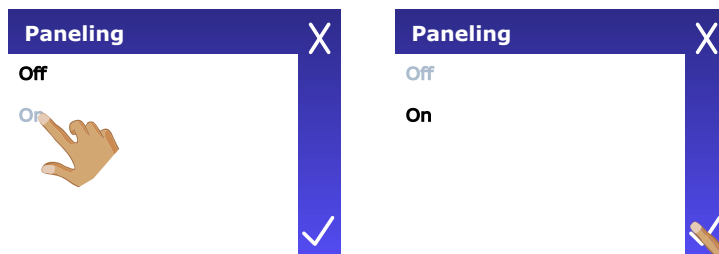

5. Tap **On**.

6. Tap  to confirm.

3.3 Automating OPOS tasks

OPOS allows you to automate certain jobs, by placing the tool above the first registration marks only once: when starting the job. This reduces user intervention and production time significantly. There are different types of automation.

Multiple copies of the same job

When cutting multiple graphics, you only need to place the OPOS sensor above the origin mark of the first graphic. Cutting subsequent graphics requires no further action from the user.

There are two multi-task situations in which OPOS can be used:

1. When cutting multiple (copies of a) graphic(s) on the same media roll (see section 3.3.1).
2. When cutting the same graphic on multiple sheets (see section 3.3.2).

Most automated jobs are organized from the cutting software. However, when the same graphic contour has to be cut out, the automated job may also require some manual manipulation.

Unattended contour cutting (roll to roll)

Along with the job, a special barcode can be printed, which is then used to access the correct cutting data, allowing the cutter to cut job after job without user intervention.

3.3.1 Cutting multiple copies of a graphic on the same roll

If the same graphic design has been printed on a roll with equal distance between these graphics, this feature can be used.



NOTE: The distance between the multiple copies should be at least 30 mm.

1. Power on the cutter and load the media (see section 1.5).

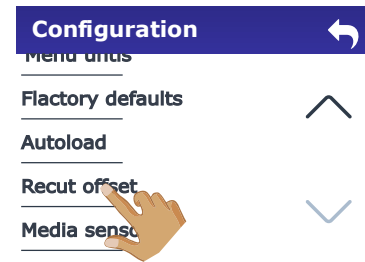
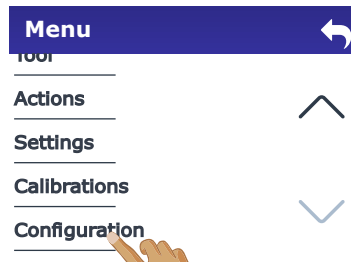
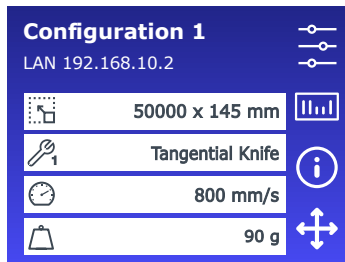

2. Tap .

3. Scroll down with the arrow and tap **Configuration**.

4. Scroll down with the arrow and tap **Recut offset**.

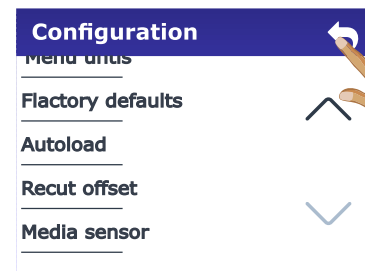

5. Use the arrows to change the value or enter the value.

6. Tap  to confirm.

7. Tap  to get online again.

8. Make the first copy as you would perform a normal OPOS job.

The cutter will stop after the first contour has been cut and will go online again.

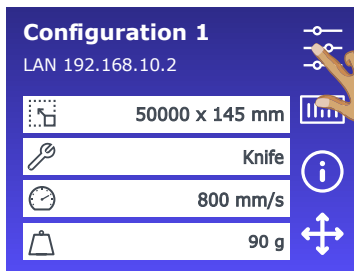

9. Tap .

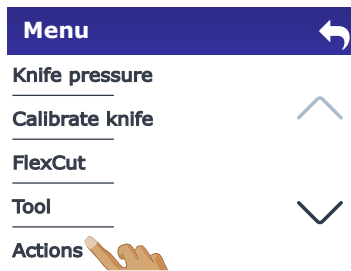

10. Tap **Actions**.

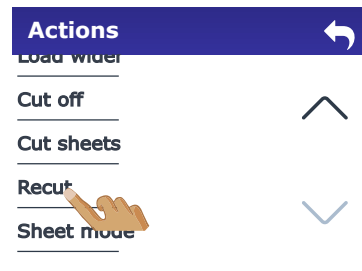

11. Scroll down with the arrow and tap **Recut**.

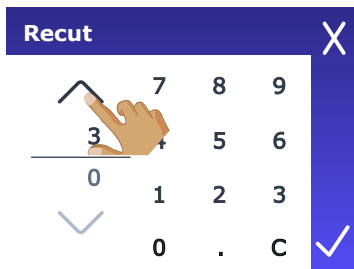

12. Use the arrows to change the value...

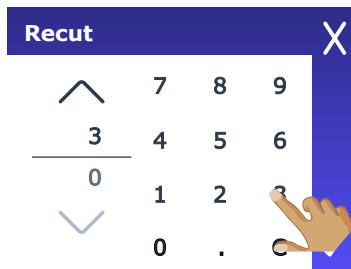

13. ...or use the numbers to enter the value.

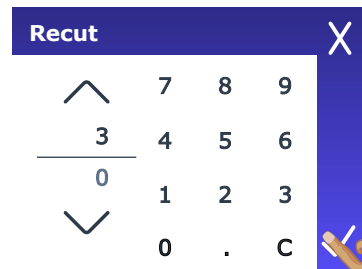

14. Tap  to confirm.

OPOS will register the marks for the second contour and then cut that contour. This process of registering and cutting will repeat itself automatically until all remaining contours are cut.

3.3.2 Cutting the same graphic on multiple media sheets

If the same graphic design needs to be printed on multiple sheets, this feature can be used.



NOTE: The sheets should be of approximately the same size and the graphics on them should be oriented and positioned in the same way.

First load the media (see section 1.5) and check whether the parameters of the OPOS marks are set correctly.

Cutting the same graphic on multiple media sheets:

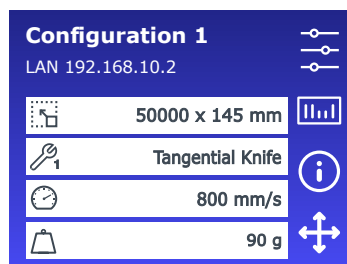

1. Tap .



2. Tap **Actions**.

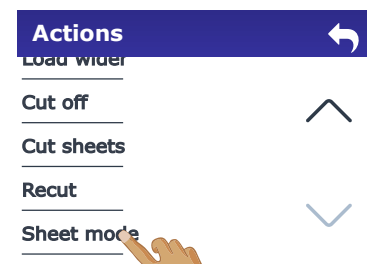

3. Scroll down with the arrow and tap **Sheet mode**.

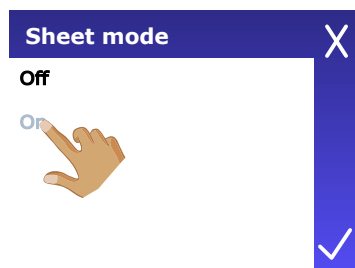

4. Tap **On**.

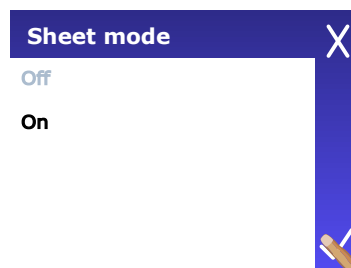

5. Tap  to confirm.

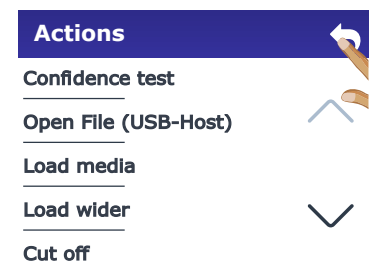

6. Tap  to get online again.

7. Perform the cutting job on the first sheet.

The cutter will stop after the first contour is cut and will go online again.

8. Raise the pinch rollers and remove the sheet manually.

9. Insert the next sheet into the cutter. Lower the pinch rollers.



NOTE: The second and subsequent sheets must be loaded into the cutter in the same position and oriented the same way as the first sheet. In OPOS sheet mode, the cutter stores the distance between the edges of the sheet and the first OPOS mark.



NOTE: Use easy reference points for quick positioning of the sheet. In the figure below, an edge of the base plate and the side of the pinch roller assembly are used to align the sheets.

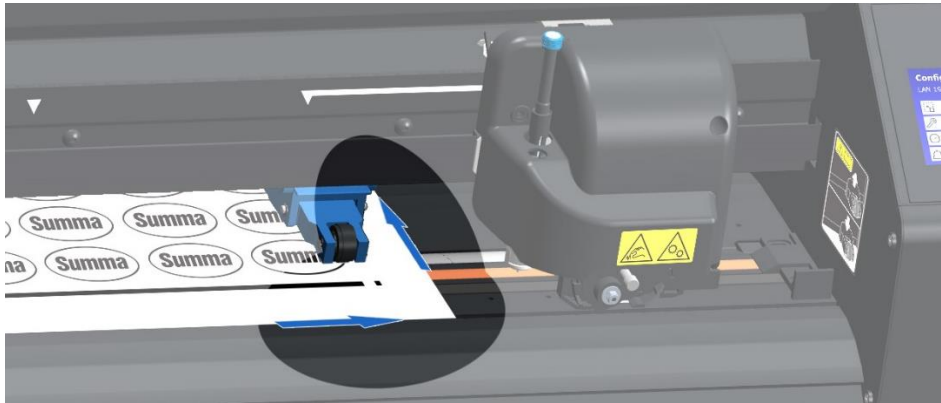

FIG 3-4
POSITIONING THE MEDIA FOR MULTIPLE SHEETS

3.3.3 OPOS Barcode

3.3.3.1 Introduction

The S Class 3 cutters can also read a barcode. Certain RIPs can print a barcode along with the OPOS marks. This barcode can then be used to identify the job and automatically retrieve the required cutting data from the computer.

A program must run on the computer that will act as a barcode server and monitor the connection to the cutter. Once a barcode has been sent by the cutter, the program will search for the corresponding file with the correct cutting data on a server (to which the RIP has written the cutting file) and send this file to the cutter. Once the file is sent, the barcode server waits again for a new barcode. This way, a complete roll can be cut without user intervention.

Depending on the program (barcode server), the procedure will either have to be started from the cutter's touchscreen or from within the program (Summa's barcode server contains both options). Please refer to the user manual of the respective program to start the barcode procedure from within the program. To start the procedure from the touchscreen, follow the procedure described in chapter 3.3.3.2.

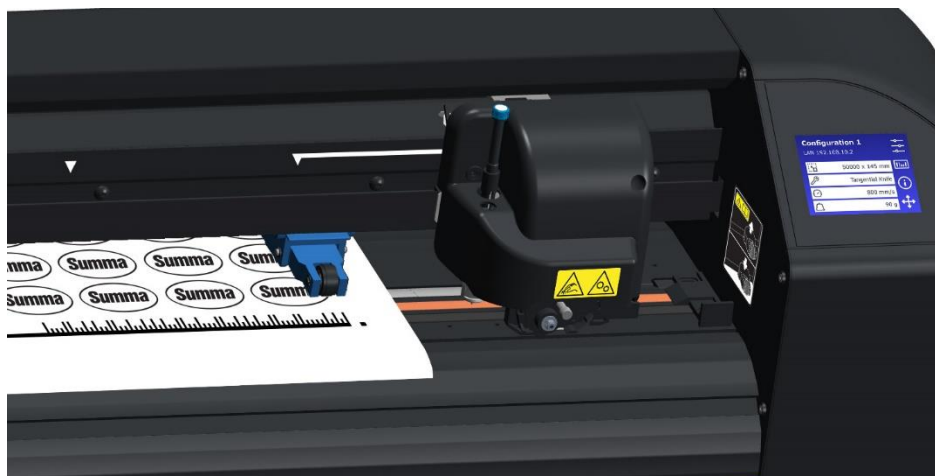
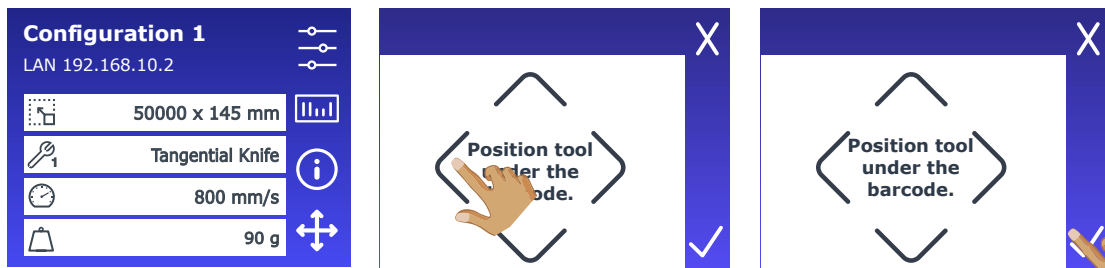



FIG 3-5
OPOS BARCODE JOB LOADED

3.3.3.2 Initiating the barcode procedure

1. Power on the cutter and load the media (see section 1.5).



2. Tap .
3. Use the arrows to position the tool under the barcode.
4. Tap  to confirm.

The cutting process starts.

- *The cutter reads the barcode and sends this data to the computer.*
- *The cutting software automatically sends the correct cutting data to the cutter.*
- *The cutter starts registering the OPOS marks and cut the job.*
- *The OPOS sensor now searches whether there is another job printed after the one just completed and continues cutting contours.*

This is repeated until all contour cutting jobs on the loaded roll have been cut.



NOTE: If the procedure is to be started from the computer (barcode server program), click the start icon in the program (please refer to the manual of this program for more information). Then go to step 3 in the above procedure.

3.4 Calibrating OPOS

To ensure that OPOS works accurately, two calibrations must be performed: the OPOS calibration and the media calibration. The OPOS calibration is the calibration of the distance between the knife tip and the sensor. The media calibration “teaches” the cutter the reflection levels of the mark colour and the media colour.



NOTE: Although the OPOS sensor is factory calibrated, Summa recommends performing a test to determine how well the factory-set parameters work with the materials you are using. If the accuracy is not satisfactory, then perform the OPOS calibration.

3.4.1 OPOS offset calibration

1. Switch on the cutter and load black vinyl that has white backing (see section 1.5).



NOTE: OPOS calibration MUST be performed using black vinyl that has white backing.

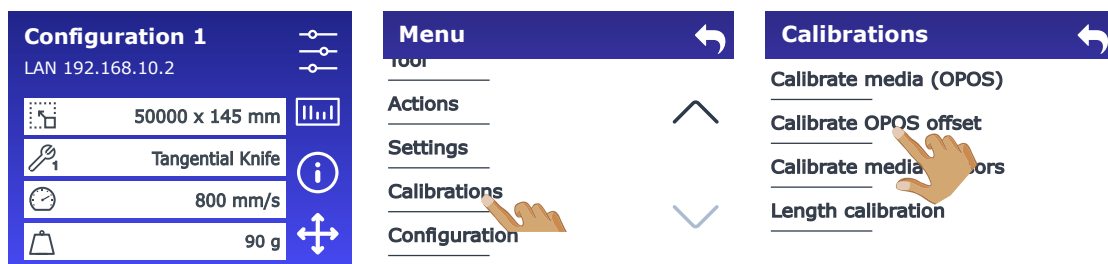

2. Tap

The cutter cuts out a square, measuring approximately 9.5x9.5 mm and moves the square forward. “Weed out Rectangle” will appear on the display.

3. Scroll down with the arrow and tap **Calibrations**.
4. Tap **Calibrate OPOS offset**.

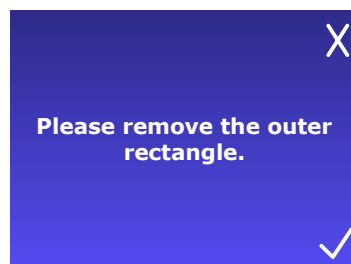

OPOS reads the edges of the square and calibrates itself as required.

5. Carefully weed out the outer rectangle, making sure the edges stay intact. Tap

6. Tap to get online again.



NOTE: To keep the OPOS sensor as accurate as possible, you should perform this calibration each time the knife is changed.

3.4.2 Calibrate media (OPOS)

Media calibration ensures that the OPOS sensor can recognize the marks. The OPOS sensor is factory calibrated to work with a wide range of materials. However, certain materials, such as those with a high gloss, may not work with the default settings. Before working with such materials, perform a media calibration test. This test will alter OPOS' sensitivity so that it will read the marks with greater reliability. Print a square of at least 4x4 cm on the media that will be used for the actual job, using the same ink as for printing the registration marks.



NOTE: If the media calibration is completed and the results have not improved, reset the media calibration value to the default value.

Perform the media calibration:

1. Switch on the cutter and load the vinyl with the printed square (see section 1.5).

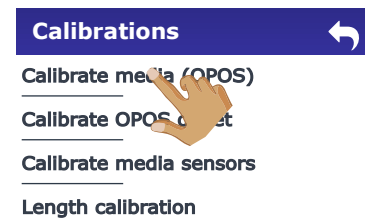
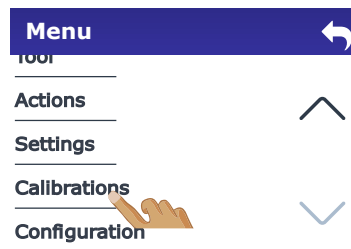
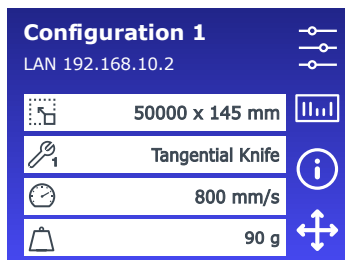

2. Tap .

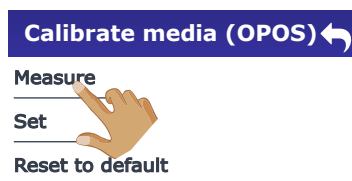

3. Scroll down with the arrow and tap **Calibrations**.

4. Tap **Calibrate media (OPOS)**.

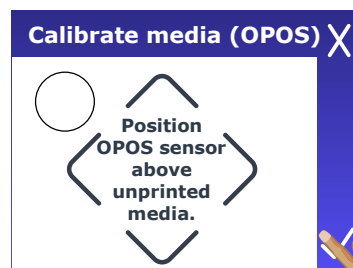

The small circle in the upper left corner shows what the OPOS sensor actually sees (white media in this case).

5. Tap **Measure**.

6. Use the arrows to position the OPOS sensor above an unprinted area.

7. Tap  to confirm.

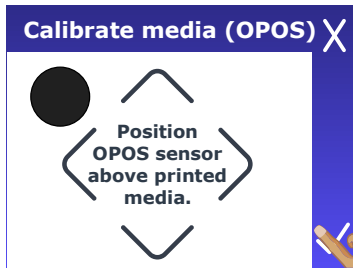

The small circle in the upper left corner shows what the OPOS sensor actually sees (white media in this case).

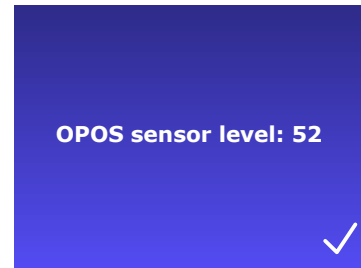

- 8. Use the arrows to position the OPOS sensor above an unprinted area.
- 9. Tap to confirm.
- 10. Tap to confirm.

Then a value is shown that is typical for this combination of media colour - mark colour. Save this value for future reference.



NOTE: An error message will appear if the sensor is not able to differentiate between black and white. Make sure that the test has been performed correctly.

Set value:

If a combination of media colour – mark colour has already been calibrated and set, this value can be entered directly. Follow the procedure on the previous page up to and including step 4, then continue with the steps below.

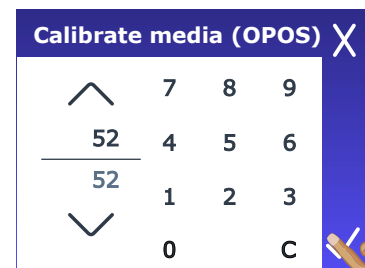
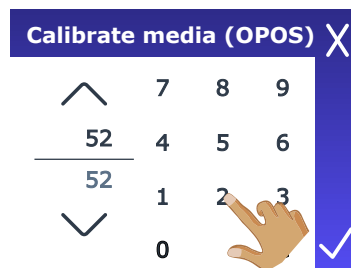
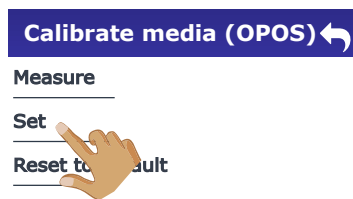

- 5. Tap **Set**.
- 6. Use the arrows to change the value or enter a value.
- 7. Tap to confirm.

Default value:

Follow the procedure on the previous page up to and including step 4, then perform the following action:

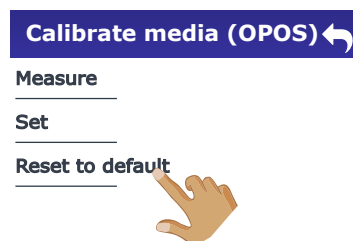

- 5. Tap **Reset to default**.

3.5 OPOS CAM on the TC models

The S Class 3 TC models are equipped with a camera instead of the standard OPOS sensor for detecting registration marks. The distinction between an S Class 3 model with a standard OPOS sensor and one with a camera becomes evident when the sensor or camera is detecting the registration marks.

A model equipped with a standard OPOS sensor lowers the sensor to the lower right corner of the tool head while registering the marks.

In contrast, a model with an OPOS CAM activates a light positioned at the lower right corner of the tool head when the camera is registering the marks.

3.5.1 Standard print and cut jobs

The camera can be used either in the same manner as the standard OPOS sensor or in combination with a computer equipped with specialized software.

Standard print and cut jobs are described in section 3.2. When such jobs are loaded, the camera operates similarly to the standard OPOS sensor, but with significantly faster reading of the registration marks.

3.5.2 Extra features OPOS camera

If the camera is used in conjunction with special Summa software (such as Summa GoSign with the Pro Pack installed), additional options become available:

1. Randomly Shaped Marks
2. Randomly Placed Marks
3. Special Compensation Methods

Randomly shaped marks refer to the usage of round and cross-shaped registration marks. Randomly placed marks indicate that it's not necessary to position the marks solely outside the job on the left and right sides; they can also be placed within white areas of the job, closer to the objects to be cut, thereby enhancing accuracy. The special compensation methods enable the retention of the original geometry of the objects intended for cutting.

For more information on these features, please consult the GoSign manual.

4.1 Introduction

This chapter includes a detailed list of all parameters that can be changed and tests that can be initiated from the touchscreen. This chapter can be used as a reference for locating a particular parameter setting or test, and it also explains the less frequently used parameters.

Tap  to access the main menu.

4.2 Main menu

The main menu contains parameter settings and submenus. Use the up and down arrows on the right to navigate through the menu.

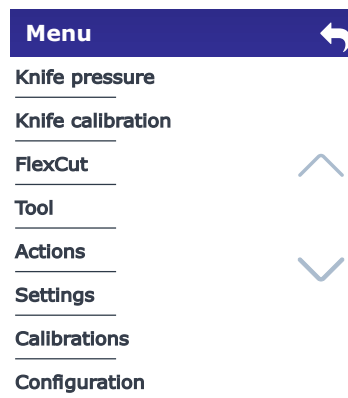

FIG 4-1
MAIN MENU

4.2.1 Tool* pressure

*Depending on what tool is installed.

This parameter is explained in section 2.3.2.

4.2.2 Tool* calibration

*Depending on what tool is installed.

This parameter is explained in section 2.3.3.

4.2.3 FlexCut

The advantage of the FlexCut feature is that it cuts completely through the media. In addition, it ensures that the material stays together by means of small media bridges.

There are 6 typical FlexCut parameters:

1. **Full pressure:** This parameter determines the full pressure that is used in FlexCut mode.
2. **Full pressure length:** This parameter determines the length that is cut at full pressure, usually the length that is cut all the way through.
3. **Flex pressure:** This parameter determines the pressure of **Flex pressure length**. This is usually a reduced pressure so that the knife only scratches the media or only cuts it halfway through.
4. **Flex pressure length:** This parameter determines the length that is cut at reduced pressure or without pressure, to form the media bridges. This is usually a much smaller value than **Full pressure length**.
5. **FlexCut Velocity:** FlexCut uses higher knife pressures. Higher knife pressures require a lower cutting speed. With this parameter, the velocity of FlexCut can be set independently from the normal cutting velocity.
6. **FlexCut panel size:** determines the size of the panel. FlexCut is usually cut in segments.

All those parameters are media dependent. Section 2.7 explains how to find the best values for these parameters.

4.2.4 Tool

Several tools, depending on the machine model, can be installed in the cutter. With this parameter the tool is selected, and all its corresponding specific parameters are shown in the menu to adjust if necessary. If the tool has been changed, use this menu to set up the machine to use the newly inserted tool. This is explained in chapter 2.3.1.

4.2.5 Submenus

The rest of the menu items in the main menu are submenus and are explained in the sections below.

4.3 Actions

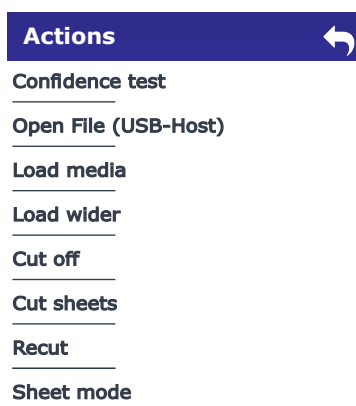

FIG 4-2
ACTION MENU

4.3.1 Confidence test

This submenu allows you to perform a quick electrical and mechanical test of the cutter to ensure that the cutter is fully operational. A media sheet of at least A3/B size must be used for this test. This test always cuts the left side of the loaded media.

4.3.2 Open File (USB stick)

Use this option to cut directly from the USB flash drive (FAT32 formatted) or to upgrade the cutter. Tap it to get the list of the files on the USB stick.



Select the file to cut then tap .

If the file contains a new firmware version, the firmware will be upgraded.

If the file contains a design, the cutter will now cut the file.



NOTE: The cutter only accepts design files with cutting data: HPGL or DMPL files made by software that is used to drive the cutter directly. Their extension can be *.plt*, *.dmpl*, *.hpgl*, or *.summa1*.

4.3.3 Load media

You can make use of this submenu when loading sheet material. The maximum loading length can be set.

4.3.4 Load wider

This action is explained in section 1.5.4.

4.3.5 Cut off

This functionality cuts off the currently loaded material.

4.3.6 Cut off sheets

Use this function to cut off a defined number of sheets from a roll with a fixed length.

4.3.7 Recut

This submenu allows you to recut the last file sent to the cutter (provided it fits in the buffer).

4.3.8 Sheet mode

This submenu allows automating jobs on sheets. See section 3.3.2.

4.4 Settings

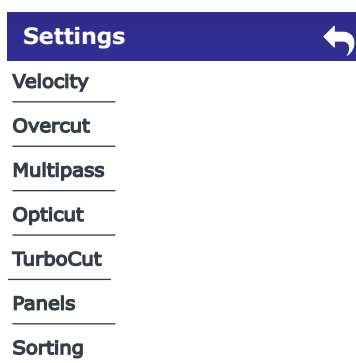

FIG 4-3
SETTINGS MENU

4.4.1 Velocity

Velocity is the bundled parameter to change the speed of the tool/media. This parameter is explained in section 2.4.

4.4.2 Overcut

This submenu allows generating an overcut to make weeding easier. Each time the knife moves up or down, the cutter first cuts a bit further. The overcut setting can be turned off (= 0) or set to any value between 0 and 10. One unit is approximately 0.1 mm or 0.004 ". Section 2.3.3 explains how to change the overcut value.

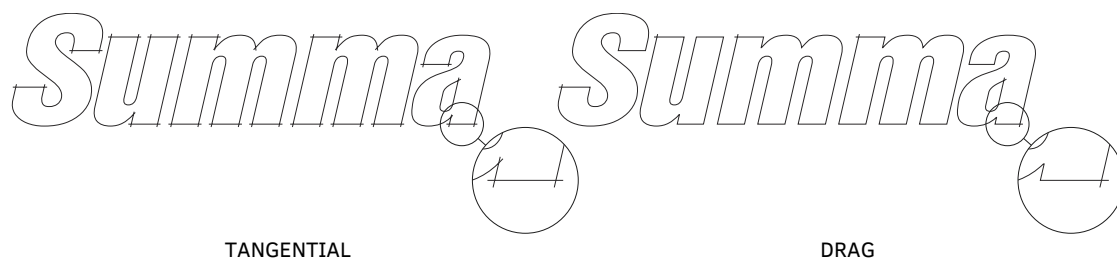

FIG 4-4
OVERCUT

4.4.3 Multipass

This function is interesting when using material that is thick and difficult to cut. This parameter can be set to cut each vector multiple times.

4.4.4 OptiCut

This submenu allows increasing the cutting quality in case the knife is worn out or not calibrated correctly. This option is default set to **Off**.

4.4.5 TurboCut

This submenu allows increasing throughput speed without increasing the overall speed of the plotter by speeding up the drag motion. Cutting time is significantly reduced, especially when cutting small, detailed designs. However, some thicker materials might not be cut properly when this feature is activated.

4.4.6 Panels

This submenu allows enabling or disabling the internal segmentation function of the cutter. Segmentation is used for several different applications. The most common are FlexCut and long jobs with or without the roll-up option.

- **Panelling:** to set panelling on or off.
- **Panel size:** to set the panel size.

4.4.7 Sorting

There are three options in this menu.

- **Off:** Default value. The vectors are not optimized. Choose this option when the intelligence of the cutter driver is preferred.
- **Directional:** The vectors are optimized for the cutting direction (media movement). Choose this option when the cutting pressure needs to be set relatively high (for example when cutting through).
- **Starting point:** Optimizes the starting point for closed curves. Choose this option when the curves do not close as they should.

4.5 Calibrations

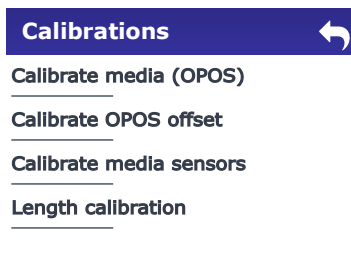

FIG 4-5
CALIBRATIONS MENU

4.5.1 Calibrate media (OPOS)

This calibration is used for particular combinations of registration mark colour and media colour. The procedure is explained in section 3.4.2.

4.5.2 Calibrate OPOS offset

This calibration determines the distance between the centre of the OPOS sensor and the knife tip. This is a media-independent calibration and may only be performed when the knife holder is removed. The procedure is explained in section 3.4.1.

4.5.3 Calibrate media sensors

The media sensors are factory calibrated and detect the end of most common media types. However, in a few rare cases, the sensors fails in doing so (e.g. media with a black backing or transparent media). In this case, the sensors can be adjusted so that they detect correctly with this kind of media.

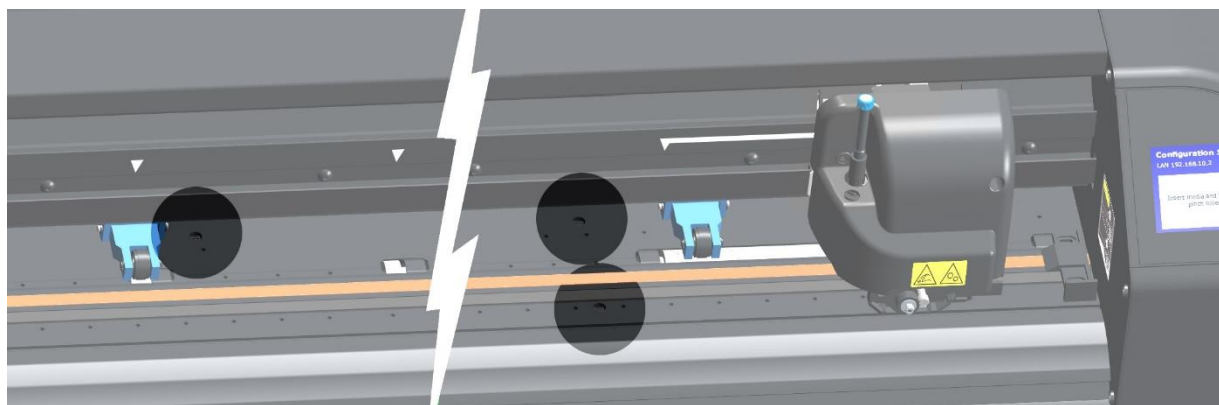

FIG 4-6
BACK SENSOR FOR MEDIA DETECTION



NOTE: Media sensor calibration is user dependent. If necessary, select a separate user for a specific type of media and calibrate the sensor. Then switch to that user every time this type of media is used again.

In the menu, you can choose to calibrate the sensor for a specific type of media or to make this the default setting. The procedure below describes how to calibrate. If in step 6 of the procedure *Reset to default* is chosen, the procedure ends there and the settings for that user for that sensor are reset to default.

1. Power on the cutter.

2. Tap .

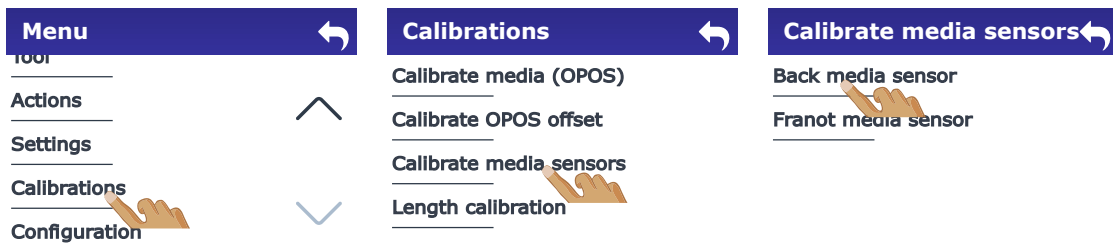

3. Scroll down with the arrow and tap **Calibrations**.
4. Tap **Calibrate media sensors**.
5. Select the sensor to calibrate by tapping **Back media sensor** or **Front media sensor**.

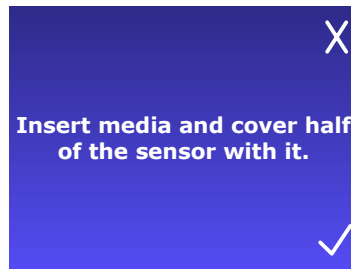
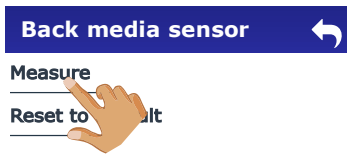

The cutter prompts you to load media until half of the sensor is covered (see section 1.5.4).

6. Tap **Measure**.
7. Tap  when this is done.

When the test starts, the cutter moves the media back and forth to cover and expose the media sensor.

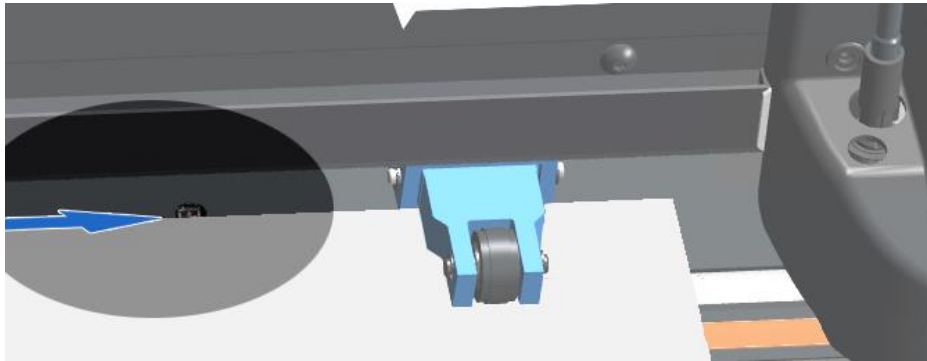
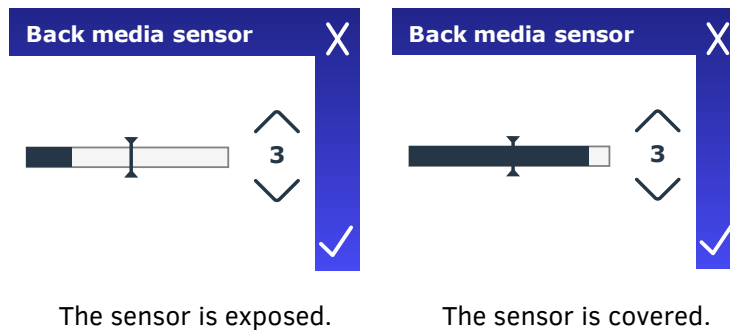

FIG 4-7
LOAD MEDIA FOR SENSOR TEST



The sensor is exposed.

The sensor is covered.

8. Use the arrows to set the sensitivity between 0 (most sensitive) and 4 (least sensitive). The sensitivity is correctly set if, when the sensor is covered, the indicator bar is (almost completely) black, and when it is not covered, (almost completely) white.
9. Ideally, the slider indicating the sensitivity trigger level I should be halfway the indicator bar, both when the sensor is covered and when it is not. If necessary, slide it to the left or to the right.

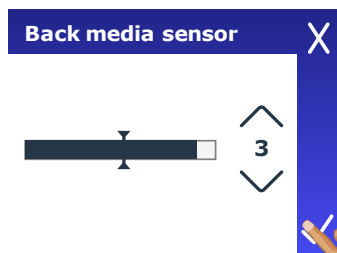

10. Trigger level is set, tap  to confirm.

4.5.4 Length calibration

Length calibration is explained in section 2.6.

4.6 Configuration

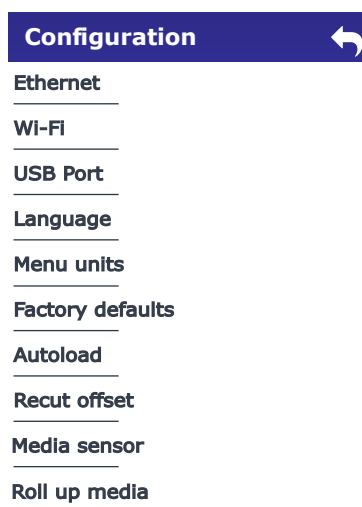

FIG 4-8
CONFIGURATION MENU

4.6.1 Ethernet

When connecting a cutter to Ethernet, several parameters need to be set in this menu. This is explained in section 1.4.2.

4.6.2 Wi-Fi

Wi-Fi setup is explained in section 1.4.3.

4.6.3 USB Port

There are four USB ports: USB port 1, USB port 2, USB port 3, USB port 4. Because of the different USB ID's, the computer can make a distinction between several cutters connected (no more than four).



ATTENTION: The USB ID in the cutting software must be the same as the selected USB ID in the cutter. Each time a new USB port is selected on the cutter and connected to the computer for the first time, Windows will launch a wizard to install a driver.



ATTENTION: This change becomes active after rebooting the cutter.

4.6.4 Language

This submenu allows setting or changing the touchscreen interface language.

4.6.5 Menu units

This submenu allows selecting whether the speed and length units are displayed in the metric or imperial system.

4.6.6 Factory defaults

This submenu allows setting all user parameters to the factory settings.

4.6.7 Autoload

This submenu allows changing the unrolling procedure for vinyl. When this function is activated, the cutter will unroll the vinyl automatically when required. If this function is deactivated, you need to manually unroll enough media before you start cutting. **Autoload** is activated by default. You can also set **Autoload** to **Ask**. In this case, the cutter does not automatically start loading vinyl after it was switched on or after the pinch rollers were lowered; a message appears on the touchscreen to adjust the pressure of the pinch rollers.



ATTENTION: Tracking is not guaranteed when **Autoload** is set to **Off**.

4.6.8 Recut offset

This submenu allows setting or changing the distance between the jobs when performing multiple recuts. The default value is 40 mm.

4.6.9 Media sensor

The media sensors detect whether media is loaded and detect the end of the media. They prevent damage to the cutting strip and knife tip. This submenu allows activating or deactivating the sensors. When the sensors are activated, the cutter searches for the front end of the media during the loading procedure. If it does not find it after moving the media backwards for 1 m (+/- 3 feet), it stops returning the media and sets the origin in the X-axis. The cutter will also stop during the loading procedure or while it is cutting if the rear sensor detects the end of the media. The cutter does not search for the front end of the media and assumes that the loaded media is endless if the sensors are not activated.

4.6.10 Roll up media

This submenu is only available on roll cutters with a roll-up motor.

The S Class 3 cutter series has several sliding surfaces made of smooth metals and plastics. They are virtually frictionless and require no lubrication. They do, however, collect dust and lint which can affect the cutter's performance. Keep the cutter as clean as possible by using a dust cover. When necessary, clean the unit with a soft cloth dampened with isopropyl alcohol or a mild detergent. Do not use abrasives.

5.1.1 Cleaning the drive system

Over time, the sleeves of the drive drum may become clogged with accumulated residue from the media backing, reducing traction.

Cleaning the drive system:

1. Unplug the power cord.
2. Apply a mild solvent (normally used to remove old glue residue) on the silver-coloured grit rollers and wait for it to dissolve the accumulated residue.
3. Clean with a brush (we recommend using a toothbrush).

Repeat the procedure for all dirty drive sleeves.

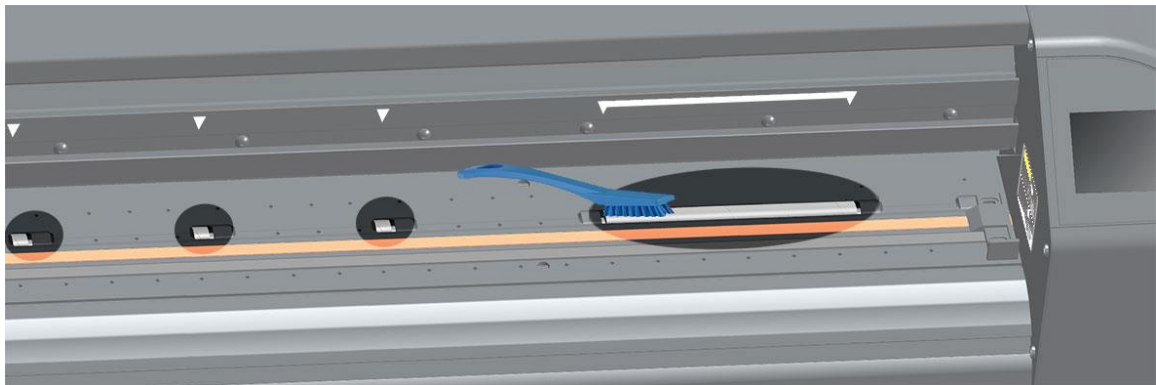

FIG 5-1
CLEANING SLEEVES

5.1.2 Cleaning the media sensors

Over time, the media sensors may become dirty with accumulated residue from the media. This may cause the cutter to malfunction.

Clean the media sensors by swiping them with cotton swabs.

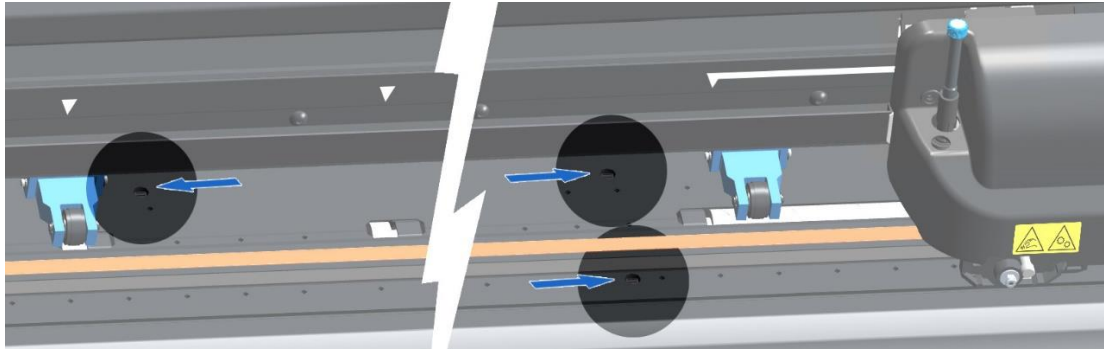

FIG 5-2
MEDIA SENSORS S THREE CUTTERS

5.1.3 Cleaning the nosepiece (tangential machine only)

The nosepiece may accumulate residue from the vinyl that will result in poor cut quality. The nosepiece needs to be cleaned if the cut line is interrupted every 12 mm (0.5").

Cleaning the nosepiece:

1. Gently remove the knife by turning the knife holder counterclockwise (1).
2. Observe the orientation of the nosepiece and then push it out of its holder (2).

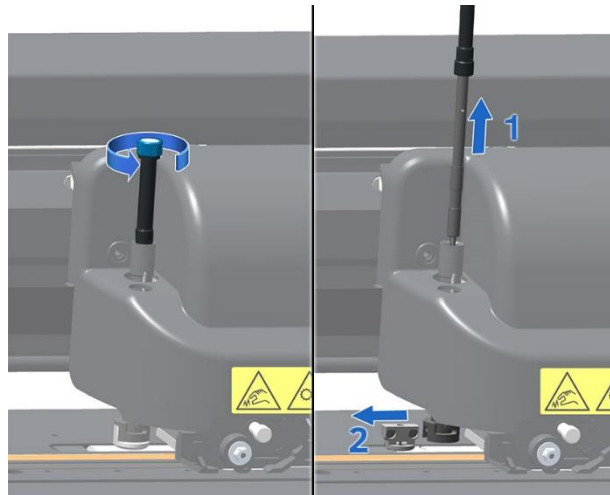

FIG 5-3
REMOVING THE TANGENTIAL KNIFE HOLDER

3. Remove any remaining vinyl residue using a brush or a pair of tweezers.

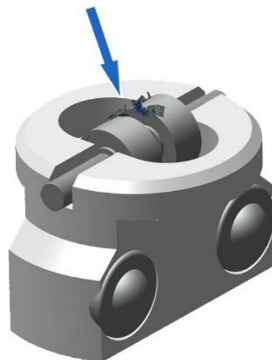

FIG 5-4
NOSE PIECE

4. Install the nosepiece.
5. Install the knife as described in section 1.6.2.1.

5.1.4 Cleaning the Y guiding rail

The tool carriage uses four sliding surfaces on the Y guiding rail: two sliding surfaces at the front of the guiding rail ① and two sliding surfaces at the rear of the guiding rail ②, directly behind the visible sliding surfaces at the front. Although the shape of the Y guiding rail may vary from model to model, the sliding surfaces are in the same place at the top and bottom of the guiding rail.

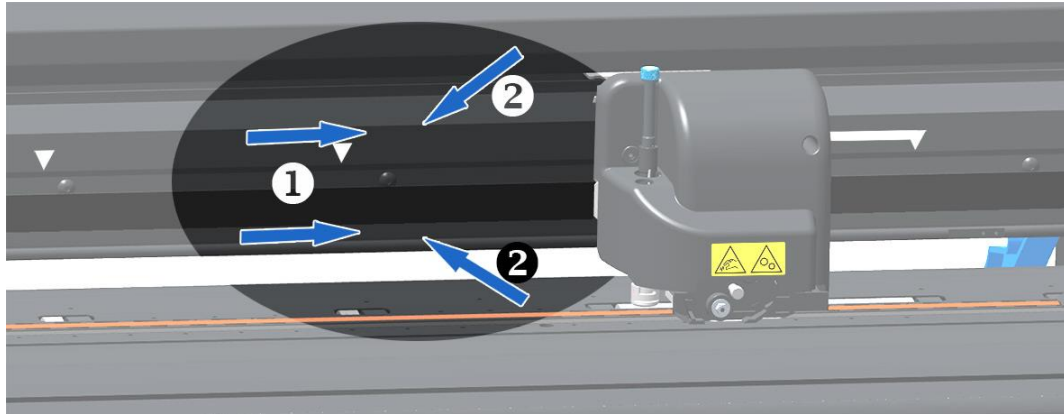

FIG 5-5
SLIDING SURFACES ON Y GUIDING RAIL

Over time, the sliding surfaces and the rollers of the tool carriage can become contaminated with accumulated residue.

Cleaning the sliding surfaces of the Y guide rail:

1. Switch off the machine.
2. Take a soft cloth dampened with isopropyl alcohol or a mild detergent.
3. Clean the surfaces. When the tool carriage is in the way, carefully slide it to the left or right.

5.1.5 Changing the fuse



WARNING: Before changing the fuses, make sure that the cutter is completely disconnected from its power source.



WARNING: For continued protection against risk of fire, replace only with fuse of the same type and having the same electrical rating: T2AH 250V.

1. To remove the fuses, slightly pry loose the release clamps of the fuse holder. The fuse holder pops out.

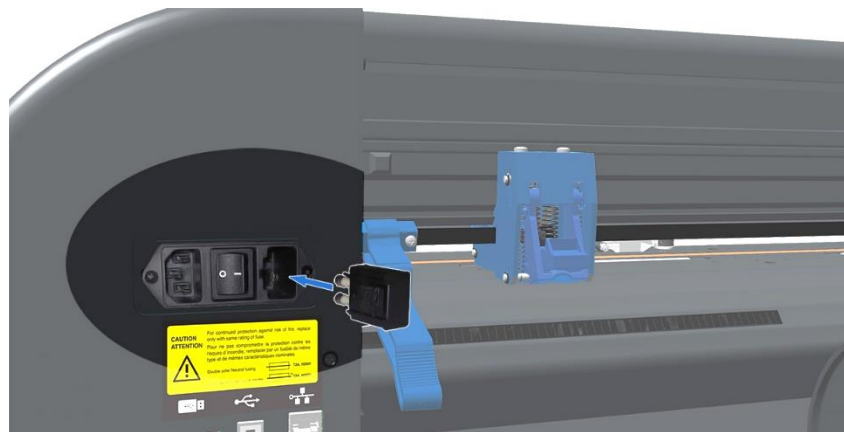

FIG 5-6
POWER ENTRY MODULE

2. Remove the fuse holder.
3. Take the fuses out of the holder.
4. Place the new fuses in the holder and click the holder back into place.

6.1 Introduction

The S Class 3TM range of cutters has been designed to produce computer-generated graphic designs on cut sheet or roll vinyl media. Using the integrated optical positioning system (OPOS X) allows contour cutting of printed sheets of material. By replacing the knife with a pen, these cutters can also be used to produce inexpensive previews of new graphic designs on paper.

6.1.1 Models

The S Class 3TM series are available in different sizes and different configurations. Depending on the region, certain sizes and or configurations may not be available. Also branding may be different. In this section we refer to the basic model names S3 75, S3 120, S3 140 and S3 160. Where known, it is marked if a specification is configuration depended.

6.1.2 Feature List

6.1.2.1 Hardware

- Drag head (model name extension: 'D' e.g. S3D75), Tangential head (model name extension: 'T' e.g. S3T75) or PRO CAM head (model name extension: 'TC' e.g. S3TC75).
- Integrated roll feed system with media flanges.
- Fully adjustable media widths.
- Stand with basket.
- Cutting strip.
- Strip for extra tool (only to be used on model names with extension 'TC').
- Pressure on outer pinch rollers can be reduced.
- Extra pinch rollers upgradable in the field.
- Separate cut off knife.
- One front and two back media sensors for media detection.
- Integrated OPOS positioning and alignment system.
- or white light sensor automatically raised and lowered with barcode recognition and OPOS X[n]-line detection on model names with extension 'D' or 'T'.
- or integrated camera with barcode recognition and OPOS X[n]-line detection on model names with extension 'TC'.
- USB memory stick slot.
- USB, Ethernet and WiFi communication interfaces.
- Integrated SMARC module on model names with extension 'TC'.

6.1.2.2 Interface

- 3.5" colored touch screen panel for convenient operator control.
- English, Spanish, French, German, Italian and Dutch.
- Metric or imperial units.

6.1.2.3 Functionality

- Eight separate user configurations stored in the non-volatile memory: (inclusive X&Y Calibration / exclusive OPOS parameters).
- Autoload for automatic media pull from roll.
- OptiCut drag-movement optimization.
- Overcut for easy weeding.
- FlexCut for cutting through.
- Panelling.
- Vector Sorting.
- Multiple recut feature (up to 999).
- Automatic cut sheet after job.
- Sheet cut function: use the cutter to cut rolls to sheets with predefined size.

6.1.2.4 Software

- GoSign
 - Finishing software for cut and print&cut jobs
 - Material Database
 - Windows 7, Windows 8 or Windows 10 (no home version)
 - Action sets to automate the workflow
 - Sorting facilities to shorten the output time
 - Material Database
 - Vector clean-up
- MacSign™
 - Plugin for Illustrator, for direct cutting to Summa roll cutter
 - MacOS X (10.2 or higher)
 - Connection by USB or TCP/IP
 - OPOS support
 - Registration required.
- Summa Cutter Control
 - Program to control cutter parameters
 - Windows 7, 8, 10 and 11
 - Utility to upgrade firmware
 - Possibility to store user configurations on hard disk
 - OPOS Barcode Server

6.1.3 Accessories

The following accessories are included in your S Class 3 cutter:

Part description	Part number	Included
Power cable (Regional differences, contact local dealer for exact part number)	-	1
USB cable	399-111	1
Razor blade	391-146	2 blades
Core holders (set of 2)	1NC40-67034	1 set
Storage compartment	395-805	1

Table 6-1 S CLASS 3 GENERAL ACCESSORIES

Part description	Part number	Included
Standard drag knife holder for drag head	393-1008	1
Standard drag knife (36°)	9TL89-67041	1

Table 6-2 S CLASS 3 ACCESSORIES FOR DRAG SERIES

Part description	Part number	Included
Tangential knife holder	395-322	1
Standard tangential knife (36°)	390-534	1
Sandblast tangential knife (60°)	390-550	1
Insertion tool for tangential knife	390-553	1
Nose piece for standard knife	395-348	1
Nose piece for Sandblast knife	395-347	1
Ballpoint pen holder	395-324	1
Ballpoint	395-325	1
Nose piece for drag knife	395-330	1
Drag knife holder for tangential head	395-323	1
Standard drag knife (36°)	9TL89-67041	1
Creasing tool for PRO CAM head	395-758	1*

* Only with TC models.

Table 6-3 S CLASS 3 ACCESSORIES FOR TANGENTIAL AND PRO CAM SERIES

6.2 Technical Specifications

6.2.1 Machine dimensions

	S3 75		S3 120		S3 140		S3 160	
	mm	inch	mm	inch	mm	inch	mm	inch
Height	1110	43.7	1110	43.7	1110	43.7	1110	43.7
Width	1410	55.5	1870	73.6	2021	79.6	2250	88.6
Depth folded basket	690	27.2	690	27.2	690	27.2	690	27.2
Depth open basket	1185	46.7	1185	46.7	1185	46.7	1185	46.7
	kg	lb.	kg	lb.	kg	lb.	kg	lb.
Weight	49.5	109	61.5	135.6	65.5	144.5	71	156.5

Table 6-4 S CLASS 3 MACHINE DIMENSIONS

6.2.2 Shipping dimensions

	S3 75		S3 120		S3 140		S3 160	
	mm	inch	mm	inch	mm	inch	mm	inch
Height	670	26.4	670	26.4	670	26.4	710	28.0
Width	1540	60.6	2000	78.7	2150	84.6	2390	94.1
Depth	560	22.0	560	22.0	560	22.0	560	22.0
	kg	lb.	kg	lb.	kg	lb.	kg	lb.
Weight	69	152	86	189	90	198	114	251

* All boxes are on a wooden pallet (Shipping dimensions include pallet).

Table 6-5 S CLASS 3 SHIPPING DIMENSIONS

6.2.3 Media handling

	S3 75		S3 120		S3 140		S3 160	
	mm	inch	mm	inch	mm	inch	mm	inch
Media Width								
Minimum	60	2.4	115	4.5	170	6.7	170	6.7
Maximum	840	33.0	1300	51.1	1450	57.0	1680	66.1
Pinch rollers	2		3		4		4	
Maximum cutting width⁽¹⁾	742	29.2	1200	47.2	1350	53.1	1580	62.2
Oversized⁽²⁾⁽³⁾	812	31.9	1270	50.0	1420	55.9	1650	64.9
Min margin left/right⁽²⁾	25	1	25	1	25	1	25	1
Front margin	45	1.8	45	1.8	45	1.8	45	1.8
Rear margin								
Sensor on	45	1.8	45	1.8	45	1.8	45	1.8
Sensor off	33	1.3	33	1.3	33	1.3	33	1.3
Tracking Performance⁽⁴⁾	± 0.1mm up to 12 m (vinyl < 760mm) ± 0.004" up to 40 feet (vinyl < 30")				± 0.1mm up to 4 m (vinyl >760mm) ± 0.004" up to 13 feet (vinyl >30")			
Media Thickness	0.05mm to 0.25mm 0.002" to 0.01"		Up to 0.8mm (0.03") with sandblast drag knife Up to 1.2mm (0.047") with sandblast tangential knife					
Cutter Media – Roll specifications	Maximum roll diameter, 16,5 cm – 6.5 inch Maximum weight 45 kg – 99.2 lbs When using core holders, inner core diameter 7,5 cm – 3 inch							
Roll-Up Media – Roll specifications	Maximum media diameter 16,5 cm – 6.5 inch Maximum weight 25 kg – 55.1 lbs Inner core diameter 7,5 cm – 3 inch							

⁽¹⁾ Maximum cutting width in normal mode, 'oversize mode' allows a wider cutting area.

⁽²⁾ For positioning of the pinch rollers, these margins can be minimized using "oversized" mode.⁽³⁾

⁽³⁾ In "Oversized" mode the tracking performance is no longer guaranteed.

⁽⁴⁾ Media lengths greater than the specified length can be handled, but compliance with specifications is not guaranteed (will be dependent on media type, media size and other parameters).

⁽⁵⁾ In contrast to the standard S Class, dual head machines have no "oversized" mode.

Table 6-6 S CLASS 3 MEDIA SPECIFICATIONS

6.2.4 Performance

Cutting specifications on 0.05 mm (0.002") wax-based vinyl, total media thickness not greater than 0.25 mm (0.010").

Axial speed	50 to 1000 mm/s	2 to 40 ips
Maximum speed	Up to 1440 mm/s	Up to 56 ips
Default speed	800 mm/s	32 ips
Acceleration	Up to 4.2 G	
Addressable resolution	0.025 mm, 0.1 mm	0.001", 0.005"
Default resolution	0.025 mm	0.001"
Mechanical resolution	6.3 µm	0.25 mil
Accuracy	0.2% of move or 0.25 mm, whichever is greater (*)	0.2% of move or 0.010", whichever is greater (*)
Knife pressure for drag head	0 to 400 gr.	
Pen pressure for drag head	0 to 400 gr.	
Knife pressure in tangential head	0 to 1000 gr.	
Pen pressure in tangential head	0 to 1000 gr.	
Pressure on optional extra pen or extra creaser	0 to 1000 gr.	

* Valid within the guaranteed tracking length (see table 6-3). Not valid in 'Oversized' Mode. Excludes differences due to media expansion, stretching, etc.

Table 6-7 S CLASS 3 PERFORMANCES

6.3 Noise level

35 dBA Cutter switched on and fan off.

48 dBA Cutter switched on and fan on.

68 dBA Cutter performing job.

Cutter was mounted on a stand equipped with a basket.

The cutting speed was set to 700 mm/s.

The media used was MacTac MacCal 8900 Pro.

6.3.1 Interface

Communication		
USB	I/O Port connector Mating connector Version	USB series "B" receptacle (female plug) USB series "B" plug (male plug) 1.1
Ethernet	I/O Port connector	RJ45 female connector
WIFI⁽¹⁾		802.11 b/g/n
USB Flash Drives	USB A receptacle	FAT32, max 16GB and max 100 files per folder. Only cut files (DMPL and HPGL files with extension .plt, .dmpl or .hpgl) or firmware files (files with extension .summa1).
Buffer size		8 MB

⁽¹⁾ Wi-Fi only available in Europe, US and Canada due to EMC tests done only according to European Directive (2014/53/EU) and according to USA & CANADA standards.

Table 6-8 S CLASS 3 INTERFACE SPECIFICATIONS

6.3.2 Firmware

Language	DM/PL, HP-GL (758x emulation), HP-GL/2
Internal cut files	Confidence test, DIN test

Table 6-9 S CLASS 3 FIRMWARE

6.3.3 Environmental

(Cutter without media)

Operating Temperature	15 to 35° C	59 to 95° F
Storage temperature	-30 to 70° C	-22 to 158° F
Relative humidity	35 - 75 %, non-condensing	

Table 6-10 S CLASS 3 ENVIRONMENTAL SPECIFICATIONS



IMPORTANT: The use of dimensionally stable media is an essential pre-requisite to obtain high cut quality. Additionally, media expansion or contraction may occur as a result of temperature variations. To improve the dimensional stability of media, let it stabilize to the current environmental conditions before use, for a minimum period of 24 hours.

6.3.4 Electrical

Voltage	Frequency	Fuse
100-240 VAC	50/60 Hz	T2AH 250V

Table 6-11 S CLASS 3 ELECTRICAL SPECIFICATIONS

Power consumption in typical applications: 85W maximum.

6.3.5 Certifications

Fulfills the requirements of:

IEC 62368-1:2018,

ANSI/UL Standard 62368-1:2019 and CAN/CSA Standard C22.2 No 62368-1:2019.

Complies with:

FCC Class A

CAN ICES-3(A)/NMB-3(A)

Contains:

FCC ID: 2ADHKATWINC1500

IC: 20266-WINC1500PB

CE Marking

Applicable legislation:

Directive 2014/53/EU on radio equipment (RED), as amended,

Directive 2011/65/EU on the restriction of the use of certain hazardous substances
in electrical and electronic equipment (RoHS2), as amended.

Standards to which Conformity is declared:

EN 62368-1:2014 + AC:2015,

EN IEC 62368-1:2020 + A11:2020,

ETSI EN 301 489-1 V2.2.3 (2019-11),

ETSI EN 301 489-17 V3.1.1 (2017-02),

ETSI EN 300 328 V2.2.2 (2019-07),

EN IEC 63000:2018.

Fulfills the requirements of:

Directive 2012/19/EU on Waste Electrical and Electronic Equipment (WEEE), as amended,

Regulation (EC) No 1907/2006 concerning the Registration, Evaluation, Authorization and
Restriction of Chemicals (REACH), as amended.